



LAYHER UNI LIGHTWEIGHT INSTRUCTIONS FOR ASSEMBLY AND USE

SAFETY STRUCTURE P2,
SAFETY STRUCTURE P2 WITH UNI TELESCOPING GUARDRAIL
AND SAFETY STRUCTURE P2 SAFETY^{PLUS}

DIN EN 1004-2-DE



Edition 09.2024

Ref. No. 8107.332

Mobile Working Platforms
According to DIN EN 1004- 1: 2021
working platform 0.75 x 1.80 m

max. working height
indoors 9.30 m
outdoors 9.30 m
permissible load capacity 2.0 kN/m²
on max. one working level
(Load class 3 according to
DIN EN 1004-1: 2021)



CONTENTS



ROLLING TOWERS WITH SAFETY STRUCTURE P2

- 1. Introduction 4
- 2. General instructions for assembly and use 5
- 3. Assembly variants
 - 3.1 Rolling Towers with Safety Structure P2 8
 - 3.1.1 Fall protection measures ... 8
 - 3.1.2 Tower models 10
 - 3.1.3 Parts list 12
 - 3.1.4 Assembly sequence 13
 - 3.1.5 Dismantling sequence 18
- 4. Castors 48
- 5. Ballasting 48
- 6. Stabiliser attachment 51
- 7. Wall support and anchoring 52
- 8. Components of the system 53
- 9. Certificate 57

▶ Go directly to page 8



ROLLING TOWERS WITH SAFETY STRUCTURE P2 WITH UNI TELESCOPING GUARDRAIL

- 1. Introduction 4
- 2. General instructions for assembly and use 5
- 3. Assembly variants
 - 3.2 Rolling towers with Safety Structure P2 with Uni telescoping guardrail 22
 - 3.2.1 Fall protection measures. 22
 - 3.2.2 Tower models 24
 - 3.2.3 Parts list 26
 - 3.2.4 Assembly sequence 27
 - 3.2.5 Dismantling sequence 32
- 4. Castors 48
- 5. Ballasting 48
- 6. Stabiliser attachment 51
- 7. Wall support and anchoring 52
- 8. Components of the system 53
- 9. Certificate 57

▶ Go directly to page 22



ROLLING TOWERS WITH SAFETY STRUCTURE P2 SAFETY PLUS WITH DOUBLE GUARDRAIL

- 1. Introduction 4
- 2. General instructions for assembly and use 5
- 3. Assembly variants
 - 3.3 Rolling towers with Safety Structure P2 SAFETY PLUS 34
 - 3.3.1 Fall protection measures.. 34
 - 3.3.2 Tower models 36
 - 3.3.3 Parts list 38
 - 3.3.4 Assembly sequence 39
 - 3.3.5 Dismantling sequence 46
- 4. Castors 48
- 5. Ballasting 48
- 6. Stabiliser attachment 51
- 7. Wall support and anchoring 52
- 8. Components of the system 53
- 9. Certificate 57

▶ Go directly to page 34



NOTE

The DIN EN 1004-2-de-compliant products or assembly variants shown in these Instructions for Assembly and Use (IAU) may be subject to country-specific regulations. Subject to local regulations, we reserve the right not to supply all of the products illustrated here.

Beyond the currently valid General Terms of Sale of Wilhelm Layher GmbH & Co KG, **no liability** is assumed for damage of whatever nature that has been incurred due to the following reasons:

- ▶ Non-compliance with instructions
- ▶ Improper assembly, and use of the product not for its intended purpose
- ▶ Use of non-original and damaged Layher components
- ▶ Unauthorised structural changes
- ▶ Improperly performed repairs, in particular when non-original Layher spare parts are used
- ▶ Events caused by force majeure (disasters, foreign objects)

The respective user shall ensure on their own responsibility that the points as stated and also the current safety regulations are complied with and that use for the intended purpose is assured.

These Instructions for Assembly and Use must:

- ▶ be available at the place of use of the Mobile Working Platform.
- ▶ be fully respected, including all the specifications they contain, during the assembly, modification and dismantling of the Mobile Working Platform. No modifications to them are permitted, or are permissible only after consultation with the manufacturer.



These instructions cannot cover all the possible applications. If you have any questions about specific applications, please contact your local Layher partner. This contact person will be happy to provide advice and answers to all questions relating to the products, to their use or to specific assembly regulations.

EXPLANATION OF SYMBOLS



Additional information and notes on the assembly, modification, dismantling and use of Mobile Working Platforms and situations in which it is necessary to consult with the manufacturer are indicated by the symbol opposite.



When assembling, modifying, dismantling or using Mobile Working Platforms, failure to observe the present Instructions for Assembly and Use and the applicable work safety regulations may result in a variety of hazards and/or require increased attention on the part of the user. Situations in which such hazards may arise and/or in which users must be required to pay increased attention are indicated by the symbol opposite.



When assembling, modifying, dismantling or using Mobile Working Platforms, failure to observe the present Instructions for Assembly and Use and the applicable work safety regulations may result in risks due to electrical voltages. Situations in which risks due to electrical voltages may arise are indicated by the symbol opposite.



When assembling, modifying, dismantling or using Mobile Working Platforms, failure to observe the present Instructions for Assembly and Use and the applicable work safety regulations may result in risks of falling. Situations in which risks of falling may arise are indicated by the symbol opposite.

1. INTRODUCTION

General

These instructions for assembly and use relate to the assembly, modification and dismantling of the **Uni Light Mobile Working Platform** with Safety Structure P2, Safety Structure P2 with Uni Telescoping Guardrail and Safety Structure P2 SAFETY^{PLUS} made by Wilhelm Layher GmbH & Co. KG of Gueglingen-Eibensbach, Germany.



Number of persons required for assembly, modification and dismantling: ▶ 2 persons

Caution: Layher Uni Light may only be assembled, modified and dismantled under the supervision of a person who has been qualified, trained and authorised for operations involving “mobile working platforms”.

2. GENERAL NOTES ON ASSEMBLY AND USE

The Mobile Working Platform may be used for the specified load class in accordance with the stipulations of DIN EN 1004 and taking into account the appropriate sections of the German Ordinance on Industrial Safety and Health (BetrSichV).

The user of the Mobile Working Platform must comply with the following instructions:

- ▶ The user must verify that the selected Mobile Working Platform is suitable for the work to be performed (Section 4 of BetrSichV).
- ▶ The maximum platform height for Mobile Working Platforms in accordance with DIN EN 1004 is
 - inside buildings: 12.00 m.
 - outside buildings: 8.00 m.
- ▶ Assembly, modification or dismantling of the Mobile Working Platform in accordance with the present IAU may only be performed under the supervision of a qualified person or by professionally suitable employees after special instruction. Only the models shown in these IAU may be built and used. The Mobile Working Platform must be inspected before, after or during assembly, but no later than before it is put into service (Section 14 of BetrSichV). During assembly, modification or dismantling, the Mobile Working Platform must be marked with a prohibition sign indicating “no entry” (BetrSichV Annex 1, Para. 3).
- ▶ It is first necessary to check that all parts, auxiliary tools and safety equipment for assembling the Mobile Working Platform are available at the site.
- ▶ All ladder frame joints must always be secured using spring clips.
- ▶ The access hatches must be kept shut whenever they are not in use.
- ▶ Mobile working platforms are not designed to be covered. Mobile working platforms are not designed to be used as side protection.
- ▶ If stipulated, the base must be widened by means, for example, of mobile beams or stabilisers or outriggers and ballast must be installed.
- ▶ Stability **must be ensured during every phase** of assembly and dismantling as well as when the platform is moved. **The necessary ballast weights and/or wall supports** (see corresponding section in these IAU) **must generally be attached before any risk of falling arises.**
- ▶ The adjustable mobile beams may only be inserted in conformity with the IAU. Any ballasting that is required must be installed prior to adjustment in accordance with the ballast specifications given in the section on “Scaffolding models”.
- ▶ To assemble the upper platforms, the individual parts must be passed up from one level to the next. Small quantities of tools and materials can be carried up by the personnel or, failing that, hoisted to the working level using transport ropes.
- ▶ In the case of intermediate platforms used solely for ascent, toe boards can be dispensed with.
- ▶ Working on two or more working levels at the same time is not permitted. In the event of exceptions, the manufacturer must be consulted. When work is being performed on several levels, they must be completely fitted with three-part side protection.
- ▶ Horizontal and vertical loads that can cause the Mobile Working Platform to topple over should be avoided, for example:
 - due to pushing against the side protection (**max. 30 kg**).
 - Due to additional wind loads (tunnel effect of through-type buildings, unclad buildings and corners).
- ▶ Before installation, all parts must be inspected to ensure they are in flawless condition. Only undamaged original parts of the Layher Mobile Working Platforms may be used. Components such as snap-on claws and spigots must be cleaned of dirt after use. Components must be secured against slipping and impacts when transported by truck. Components must be handled in such a way that they are not damaged.
- ▶ The Mobile Working Platforms must not be subjected to any aggressive fluids or gases.
- ▶ Couplers in the structures must be tightened to 50 Nm.

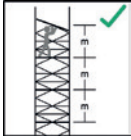

The maximum distance between the platforms must not exceed 2.25 m. Exception: The distance between the assembly level (the ground) and the first platform. The maximum distance permitted here is 3.40 m.



Mobile Working Platforms must be set to the perpendicular using the adjusting spindles or by inserting suitable materials underneath them. The max. permitted inclination is 1% (in horizontal direction = scaffolding length / 100).



Movement is only permitted on sufficiently firm ground with a max. inclination of 4% (approx. 2.5°) in the longitudinal direction or perpendicular to this, and the speed must not exceed normal walking pace (4 km/h). All impacts must be avoided.

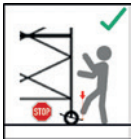

After movement, the wheels must be locked by pressing down the brake lever.



When used in the open air or in open buildings, any **work on the Mobile Working Platform must be stopped immediately if the wind strength exceeds 6 on the Beaufort scale.** At these wind speeds or at the end of a shift, Mobile Working Platforms must be moved to a location where they are protected from the wind or must be or suitable measures must be taken to secure them against toppling over.



A wind strength of more than 6 can be recognized by noticeable difficulty in walking. If possible, Mobile Working Platforms used outside buildings must be securely fastened to the building itself or to another structure. It is recommended that Mobile Working Platforms be anchored if they are left unattended.

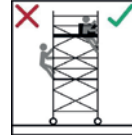

Upward access to Mobile Working Platforms is permitted only on the inside of the scaffolding structure. External access is not permitted.

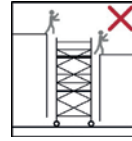

It is not permitted to climb onto and across different Mobile Working Platforms, to climb onto Mobile Working Platforms from other objects or structures or to jump onto deck surfaces.



Due to the maximum load-bearing capacity of the structure, there may be a limit to the number of persons allowed to be present on a working level at any given time. This maximum load on the working level due to persons, tools and material must be checked in advance and be limited if necessary.



Failure to respect the maximum load limit can overload the structure and/or cause it to collapse. Serious or fatal injuries are possible.



It is not permitted to increase the platform height by using ladders, boxes or other mechanisms.

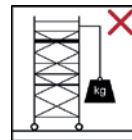

It is not permitted to lift heavy objects by attaching and using lifting gear at Mobile Working Platforms.

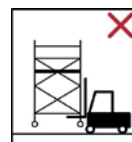

It is not permitted to lift Mobile Working Platforms using mechanical equipment.

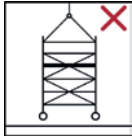

In the standard version, Mobile Working Platforms are not designed to be lifted or suspended.



In certain cases, and following consultation with the manufacturer, it may be possible to reinforce the structure by replacing the appropriate components.



It is not permitted to move the Mobile Working Platform when persons and/or loose objects are present on it.



It is not permitted to stand and move around on unsecured levels/platforms of Mobile Working Platforms.

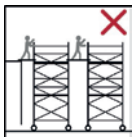

In the standard version, it is not permitted to establish bridges between different Mobile Working Platforms or between Mobile Working Platforms and other objects or structures.



In certain cases, and following consultation with the manufacturer, it may be possible to reinforce the structure by replacing the appropriate components (special construction form) and a special verification of stability or structural calculation must then be performed for this.

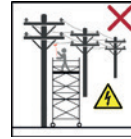

When working with Mobile Working Platforms at or in the vicinity of electrical equipment and overhead cables, it is necessary to respect the following additional instructions.

It is only permissible to assemble and use Mobile Working Platforms if:

- ▶ the equipment is no longer live.
- ▶ the deactivated equipment has been secured against reactivation.
- ▶ the equipment has been checked to ensure that no voltage is present.
- ▶ neighbouring live parts have been secured by means of protective mechanisms.
- ▶ in the case of work performed in the vicinity of overhead electrical cables, an adequate safety distance as specified in VDE 0105-100 can be / is respected.



3.1 ROLLING TOWERS WITH SAFETY STRUCTURE P2

3.1.1 FALL PROTECTION MEASURES

Suitable measures for fall protection must be taken during assembly, modification or dismantling of the scaffolding structure. Safety Structure P2 implements these protective measures in full.

Safety Structure P2

- ▶ Platforms with vertical spacing of 2 m.
- ▶ Safer design with integrated, collective side protection.

Thanks to the platforms, which are assembled 2 m apart, the hand-rails can already be fitted from the level underneath and intermediate rails can be fitted from the secured area of the access hatch, so that when the next platform up is accessed there is already a two-part side protection in place on all sides.





- 1.** Attach the first ladder frame.
Attach the Uni assembly hooks and position the second ladder frame in order to fit the guardrails.

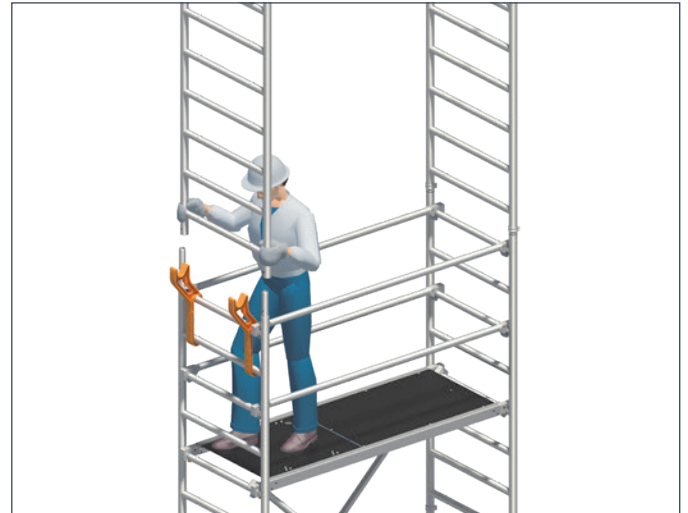

- 2.** Swivel the ladder frame with guardrail upwards and fit it in place.

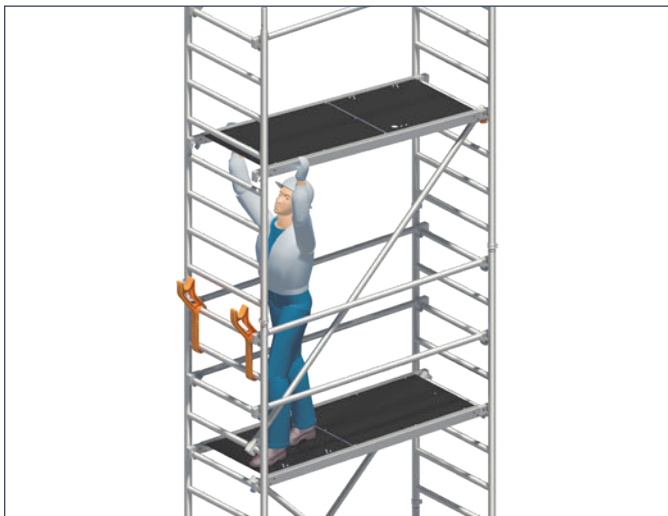

- 3.** Insert diagonal braces and access deck.



- 4.** Assemble the intermediate rails from a secured position in the area of the access hatch.

3.1.2 TOWER MODELS

1403201 – 1403207

For **assembly outdoors**, comply with the height restriction!

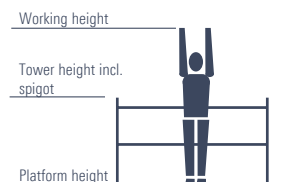

1403201



1403202



1403203



1403204



1403205



1403206



1403207

Tower model	1403201	1403202	1403203	1403204	1403205	1403206	1403207
Working height [m]	3.11	4.26	5.26	6.26	7.26	8.26	9.26
Tower height [m]	2.34	3.49	4.49	5.49	6.49	7.49	8.49
Platform height [m]	1.11	2.26	3.26	4.26	5.26	6.26	7.26
Weight [kg] (without ballast)	65.5	134.2	160.8	182.6	209.2	231.0	257.6
Ballasting (stated in units)							
Indoors							
Assembly, central	I4 r4	0	0	I2 r2	I3 r3	I5 r5	I6 r6
Assembly, off-centre	X	0	L0 R2	L0 R4	L0 R6	L2 R8	L2 R10
Assembly, off-centre with wall bracing	X	0	0	L2 R2	L4 R2	L6 R4	L6 R6
Outdoors							
Assembly, central	I4 r4	0	0	I3 r3	I5 r5	I9 r9	I13 r13
Assembly, off-centre	X	0	L0 R4	L0 R6	L0 R10	L4 R14	X
Assembly, off-centre with wall bracing	X	0	0	L4 R2	L6 R4	L10 R8	X

X = not permissible / not possible 0 = no ballast required For ballasting, use Layher ballast weights, Ref. No. 1249.000, of 10 kg each.

The weights are fastened quickly and securely at the right place using the handwheel coupler. All heights stated without possible spindle extension! The max. spindle extension of the relevant assembly variants can be found in the corresponding section! **Do not use any liquid or granular ballast substances. The ballast weights must be distributed evenly to all ballasting fixing points.**

Example: I2, r2 → Fasten 2 ballast weights of 10 kg each to the ladder frame on its left-hand side, and 2 ballast weights of 10 kg each on its right-hand side.

L6, R16 → Fasten 6 ballast weights of 10 kg each to the mobile beam on its left-hand side, and 16 ballast weights of 10 kg each on its right-hand side

In the case of off-centre assembly, r and R always relate to the side facing away from the tower; I and L relate to the side facing the tower.

1403222 – 1403227 with stabilisers, extendible

For **assembly outdoors**, comply with the height restriction!

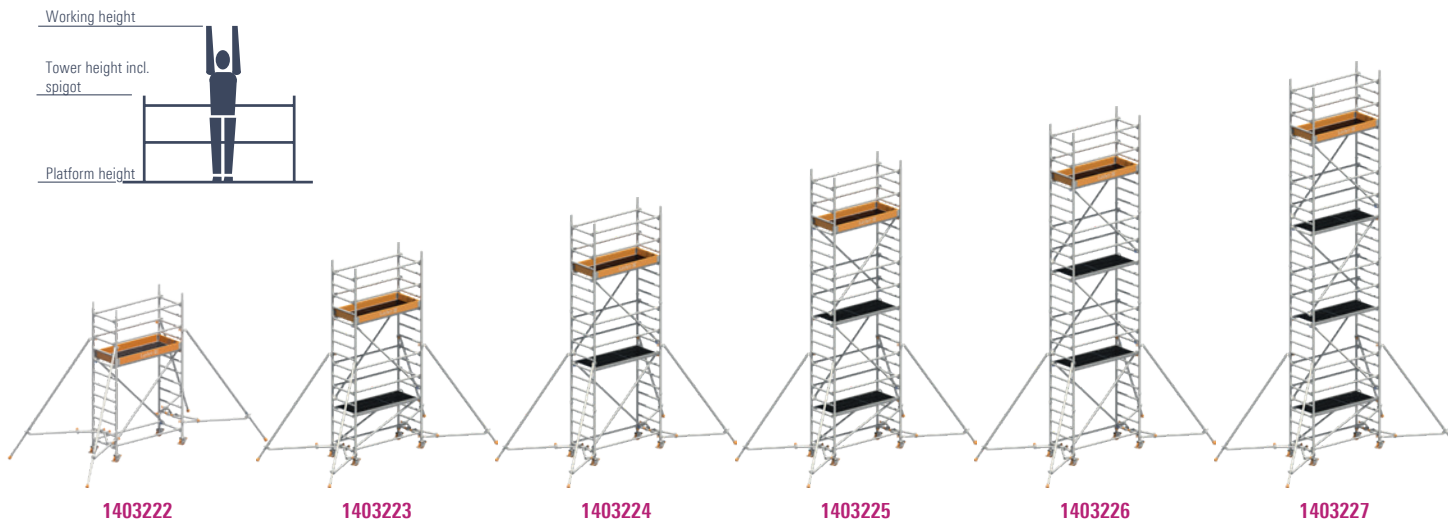

Tower model	1403222	1403223	1403224	1403225	1403226	1403227
Working height [m]	4.10	5.10	6.10	7.10	8.10	9.10
Tower height [m]	3.35	4.33	5.33	6.33	7.33	8.33
Platform height [m]	2.10	3.10	4.10	5.10	6.10	7.10
Weight [kg] (without ballast)	130.5	166.4	177.2	214.8	225.6	263.2
Ballasting (stated in units)						
Indoors						
Assembly, central	0	0	0	0	l2 r2	l2 r2
Assembly, off-centre	0	LO R4	LO R8	LO R10	LO R12	LO R14
Assembly, off-centre with wall bracing	0	0	0	0	0	0
Outdoors						
Assembly, central	0	0	0	l3 r3	l6 r6	l8 r8
Assembly, off-centre	0	LO R6	LO R10	LO R14	X	X
Assembly, off-centre with wall bracing	0	0	0	0	0	l2 r0

X = not permissible / not possible 0 = no ballast required For ballasting, use Layher ballast weights, Ref. No. 1249.000, of 10 kg each. The weights are fastened quickly and securely at the right place using the handwheel coupler. All heights stated without possible spindle extension! The max. spindle extension of the relevant assembly variants can be found in the corresponding section! **Do not use any liquid or granular ballast substances.**

The ballast weights must be distributed evenly to all ballasting fixing points.

Example: l2, r2 → Fasten 2 ballast weights of 10 kg each to the ladder frame on its left-hand side, and 2 ballast weights of 10 kg each on its right-hand side.
l6, R16 → Fasten 6 ballast weights of 10 kg each to the mobile beam on its left-hand side, and 16 ballast weights of 10 kg each on its right-hand side
In the case of off-centre assembly, r and R always relate to the side facing away from the tower; l and L relate to the side facing the tower.

3.1.3 PARTS LIST

Safety Structure P2, tower models 1403201 – 1403207

Tower model	Ref. No.	1403201	1403202	1403203	1403204	1403205	1403206	1403207
Guardrail 1.80 m	1205.180	0	4	9	8	13	12	17
Double guardrail 1.80 m	1206.180	2	0	0	0	0	0	0
Diagonal brace 2.50 m	1208.180	0	2	2	4	4	6	6
Diagonal brace 1.95 m	1208.195	0	0	2	0	2	0	2
Basic tube 1.80 m	1211.180	0	1	1	1	1	1	1
Deck 1.80 m	1241.180	0	1	0	1	0	1	0
Access deck 1.80 m	1242.180	1	1	2	2	3	3	4
Spring clip	1250.000	0	8	8	12	12	16	16
Ladder frame 75/4 - 1.00 m	1297.004	0	2	0	2	0	2	0
Ladder frame 75/8 - 2.00 m	1297.008	2	2	4	4	6	6	8
Uni assembly hook	1300.010	0	1	1	1	1	1	1
Castor 400 - 4 kN	1301.150	4	4	4	4	4	4	4
Mobile beam 1.80 m with ledger	1323.180	0	2	2	2	2	2	2
End toe board 0.75 m	1438.075	2	2	2	2	2	2	2
Toe board 1.80 m with claw	1439.180	2	2	2	2	2	2	2
Ballast	1249.000	For number of ballast weights, see Section 3.1.2: Tower models						

Safety Structure P2 with stabiliser, extendable Tower models 1403222 – 1403227

Tower model	Ref. No.	1403222	1403223	1403224	1403225	1403226	1403227
Guardrail 1.80 m	1205.180	6	10	10	14	14	18
Diagonal brace 2.50 m	1208.180	2	2	4	4	6	6
Diagonal brace 1.95 m	1208.195	0	2	0	2	0	2
Access deck 1.80 m	1242.180	1	2	2	3	3	4
Telescoping stabiliser - 2.60m	1248.260	4	4	4	4	4	4
Rotation lock for stabiliser	1248.261	4	4	4	4	4	4
Spring clip	1250.000	4	4	8	8	12	12
Ladder frame 75/4 - 1.00 m	1297.004	2	0	2	0	2	0
Ladder frame 75/8 - 2.00 m	1297.008	2	4	4	6	6	8
Uni assembly hook	1300.010	1	1	1	1	1	1
Castor 400 - 4 kN	1301.150	4	4	4	4	4	4
End toe board 0.75 m	1438.075	2	2	2	2	2	2
Toe board 1.80 m with claw	1439.180	2	2	2	2	2	2
Ballast	1249.000	For number of ballast weights, see Section 3.1.2: Tower models					

3.4 ASSEMBLY SEQUENCE SAFETY STRUCTURE P2

Observe the general directions for assembly and use on pages 5 – 7. The assembly examples shown are intended for use up to a maximum platform height of 12 m indoors and up to a maximum platform height of 8 m outdoors. Snap the snap-on claws of all parts into the ladder frames from above. Level the scaffolding structure after basic assembly.



The wheels must be locked during assembly, modification or dismantling and while there is anybody on the scaffolding structure.

Hammer home the wedges in the system until the blow bounces off. Always tighten the screw couplers well (50 Nm).

At the top level, instead of two guardrails **20**, it is also possible to fit a double guardrail **21** or a tower beam **24**. In this case, please note that additional guardrails **20** for an entire level must be present for assembly and dismantling in order to ensure collective side protection as required for the employed assembly variant. These can be removed again after inserting the double guardrails **21** or the tower beam **24**.

The **item numbers** for the components relate to the component list on pages 53 – 56.

BASIC ASSEMBLY Tower model 1403201



1. Insert the castors **1** in the ladder frames 75/8 **18** and secure them against falling out using the associated bolts and nuts.
2. Connect the two ladder frames 75/8 **18** to two double guardrails **21**. Hook the access deck **31** into the fourth rung from the bottom of the ladder frames 75/8 **18**.

Further assembly is performed as per page 17, "Completing the working platform".

BASIC ASSEMBLY

Tower models
1403202,
1403204 and
1403206



1. Insert the castors **1** into the mobile beams **8/9** and secure them against falling out with the associated bolts and nuts.
2. The mobile beams **8/9** must be connected with a basic tube **12** – or optionally with abasic strut **13** – and a deck **30**.
3. Fit two ladder frames 75/4 **17** on the mobile beams and secure using spring clips**19**.

Further assembly is performed as per page 16, “Assembly of intermediate platforms”.

BASIC ASSEMBLY

Tower models
1403203,
1403205 and
1403207



1. Insert the castors **1** into the mobile beams **8/9** and secure them against falling out with the associated bolts and nuts.
2. The mobile beams **8/9** must be connected to one another with a basic tube **12** – or optionally with a basic strut **13** – and a guardrail **20** at the access ledger of the mobile beam.
3. Fit a ladder frame 75/8 **18** on the mobile beam **8/9** and secure it using spring clips **19**. Hook in two guardrails **20** at the topmost rung and connect to a second ladder frame 75/8 **18**. Then fit the second ladder frame 75/8 **18** at the mobile beam and secure using spring clips **19**.

Any double guardrails that might be in stock must be installed as side protection for the first level. The guardrails previously installed as advancing side protection are removed again after fitting of the double guardrails.

4. Fit two diagonal braces **26** and an access deck **31**. **Ensure that the two diagonal braces are installed parallel to one another in the direction of the access hatch.**
5. Before going up, fit two additional guardrails **20** as intermediate rails to the second rung above the standing surface, starting from the assembly surface (floor/ground).

Further assembly is performed as per page 16, “Assembly of intermediate platforms”.

BASIC ASSEMBLY
Tower models
1403222,
1403224 and
1403226



1. Insert the castors **1** in the ladder frames 75/4 **17** and secure them against falling out using the associated bolts and nuts.
2. Fit further ladder frames 75/8 **18**. Connect the two rolling tower side parts at the top rungs and at the bottom rungs with two guardrails **20** in each case.
3. Fit two diagonal braces **25** crosswise. Then hook in an access deck **31**. Assemble two guardrails **20** at the bottom rung of the ladder frame 75/4 **17**.
4. To maintain the maximum distance from the first rung, fit an access ledger **14** on the ascent side of the rolling tower.
5. Climb up on the inside using the rungs of the ladder frame and through the access hatch provided. While sitting in the access hatch opening, protected from falling by the sides of the access deck **31**, assemble the intermediate rail of the next level: to do so, fit the guardrails **20** to the second rungs above the standing surface (see also "Assembly of intermediate platforms", item 5).

Further assembly is performed as per page 16, "Assembly of intermediate platforms". Further assembly for model 1403222 is performed as per p. 17 "Completing the working platform".

BASIC ASSEMBLY
Tower models
1403223,
1403225 and
1403227



1. Insert the castors **1** in the ladder frames 75/8 **18** and secure them against falling out using the associated bolts and nuts.
2. Connect the two rolling tower side parts at the top rungs and at the bottom rungs with two guardrails **20** in each case.
3. **Fit two diagonal braces **26** and an access deck **31**. Ensure that the two diagonal braces are installed parallel to one another in the direction of the access hatch.**
4. To maintain the maximum distance from the first rung, fit an access ledger **14** on the ascent side of the rolling tower.
5. Before going up, fit two additional guardrails **20** as intermediate rails to the second rung above the standing surface, starting from the assembly surface (floor/ground).

Further assembly is performed as per page 16, "Assembly of intermediate platforms".

ASSEMBLY OF INTERMEDIATE PLATFORMS

All tower models with Safety Structure P2

i Repeat the following assembly steps 1 to 5 several times depending on the assembly height.

1. Mount the first ladder frame 75/8 **18** and secure it using spring clips **19**.



2. Attach the Uni assembly hooks **32** and position the second ladder frame 75/8 **18** in order to fit the guardrails **20**.

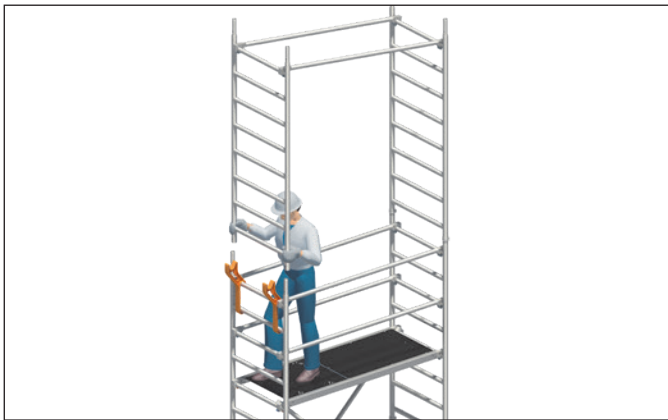

3. Swivel the ladder frame 75/8 **18** with guardrails **20** upwards, fit it in place and secure it with spring clips **19**.

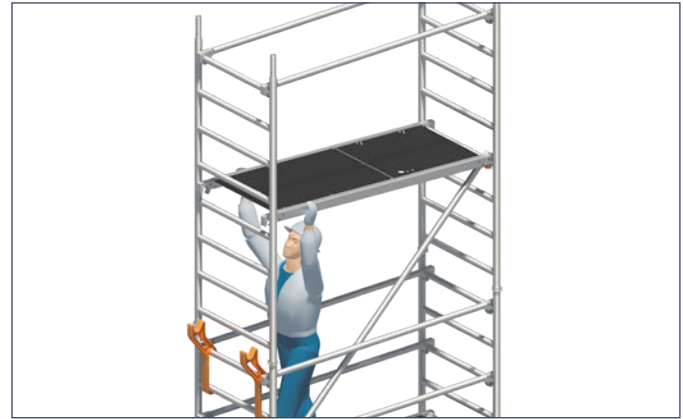

4. Insert diagonal braces **25** and access deck **31**. Install the diagonal braces on both sides in tower-like form (so that they zig-zag).



5. Climb up on the inside using the rungs of the ladder frame and through the access hatch provided. While sitting in the access hatch opening, protected from falling by the sides of the access deck **31**, assemble the intermediate rail of the next level: to do so, fit the guardrails **20** to the second rungs above the standing surface.

COMPLETING THE WORKING PLATFORM

All tower models for creating the required working platform

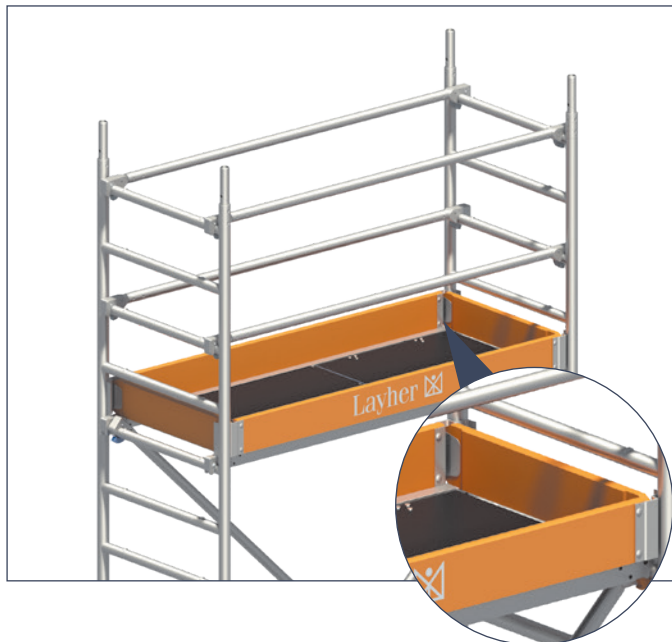

To complete the working platform, attach toe boards with claw **33** and end toe boards **34** .



If an intermediate platform is used as a working platform, it is also necessary to attach toe boards here.

3.1.5 DISMANTLING SEQUENCE SAFETY STRUCTURE P2

 Repeat the following dismantling steps 1 to 7/14 several times depending on the assembly height.

Dismantling is performed in the reverse order to assembly.

When dismantling, do not remove the bracing elements such as diagonal braces, guardrails or access decks until the ladder frames above them have been dismantled.

To lift out the individual parts, open the snap-on claws by pressing their locking clips.



1. Dismantle the toe boards **33/34** (only necessary on the working platform).
2. Dismantle the intermediate rails of the relevant level while sitting in the trapdoor opening, protected from falls by the sides of the access deck **31**. To do this, remove the guardrails **20** at the second rungs above the standing surface. If the snap-on claws of the guardrails **20** are not reachable from the sitting position in the access hatch opening, dismantle as described in point **8**. below.



3. Dismantle the access deck **31** and diagonal braces **26**.
4. Attach the Uni assembly hooks **32** at the side of the access hatch opening above and remove the spring clips **19** on one side.
5. Lift out the ladder frame **75/8 18** on the side of the Uni assembly hooks, swivel downwards with the guardrail and position in the previously mounted Uni assembly hooks **32**.



6. Detach the guardrails on one side **20** from the positioned ladder frame.



7. Dismantle the guardrails **20** by opening the snap-on claw using one of the intermediate rails dismantled under point **2**. Place the loose guardrail **20** from above onto the second rung and use it as a lever for opening the snap-on claw (see detail).

ALTERNATIVE DISMANTLING SEQUENCE



8. While sitting in the access hatch opening, protected from falling by the sides of the access deck **31**, dismantle and put down the snap-on claws of both handrails on one side, the side of the access hatch, 1 metre above the standing surface.
9. After climbing down to the platform underneath, dismantle the access deck **31** and the diagonal braces **26**.
10. Attach the Uni assembly hooks **32** at the side of the access hatch opening above and remove the spring clips **19** on one side.





11. Lift out the ladder frame 75/8 **18** on the Uni assembly hook side and swivel it downwards with the handrails released on one side under **8**. and with the still attached intermediate rails, in order to position this unit into the previously fitted Uni assembly hooks **32**. When swivelling it down, make sure that the guardrails **20** released on one side at the top rung of the ladder frame are able to slide outwards, allowing the complete unit to be positioned in the Uni assembly hooks **32**.



12. Moving the upper guardrails **20**, already released on one side, on the outside past the upper ends of the ladder frame positioned in the Uni assembly hooks **32** allows these to be positioned for later dismantling.



13. Using the end toe board or a guardrail additionally available, to act as extensions, release the locking clip of the snap-on claws on one of the still attached intermediate rails or guardrails **20** about 2.5 metres up in order to lift out the snap-on claw on one side. After that, release the guardrail **20** released on one side, at the side in which it is positioned in the Uni assembly hooks **32**, and remove it by rotating it 90° about its own axis.



14. Lift out the second remaining intermediate rail or guardrail **20** on one side, the side in which it is positioned in the Uni assembly hooks, and swivel the ladder frame 75/8 **18** into the Uni assembly hooks **32** into a vertical position, so that the three guardrails **20** still remaining can then be removed using the guardrail **15** already removed under **8**. as an extension. Place the loose guardrail **20** onto the rung underneath, for use as a lever to open the locking clip of the snap-on claw (see detail).

3.2 ROLLING TOWERS WITH SAFETY STRUCTURE P2 WITH UNI TELESCOPING GUARDRAIL

3.2.1 FALL PROTECTION MEASURES

Suitable measures for fall protection must be taken during assembly, modification or dismantling of the scaffolding structure. Safety Structure P2 with Uni telescoping guardrail implements these protective measures in full.

Safety Structure P2 with Uni telescoping guardrail

- ▶ Platforms with a vertical spacing of 2 m.
- ▶ Safer design with integrated, collective and advancing side protection.

Thanks to the platforms, which are assembled 2-m apart, both the handrails and the intermediate rails (Uni telescoping guardrails) can be fitted from the level underneath, so that when the next platform up is accessed there is already a double side protection in place on all sides.





1. Attach the first ladder frame. Attach the Uni assembly hooks and position the second ladder frame in order to fit the guardrails as well as the Uni telescoping guardrails as intermediate rails.

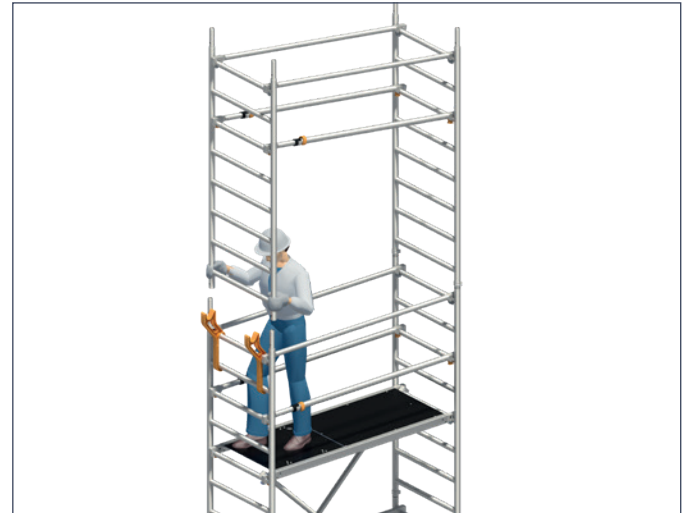

2. Swivel the ladder frame with the guardrails and Uni telescoping guardrails upwards and mount on the ladder frame underneath.

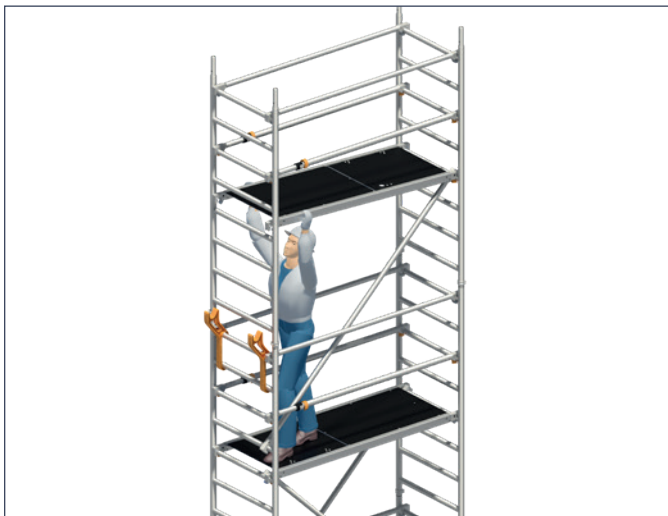

3. Insert diagonal braces and access deck.

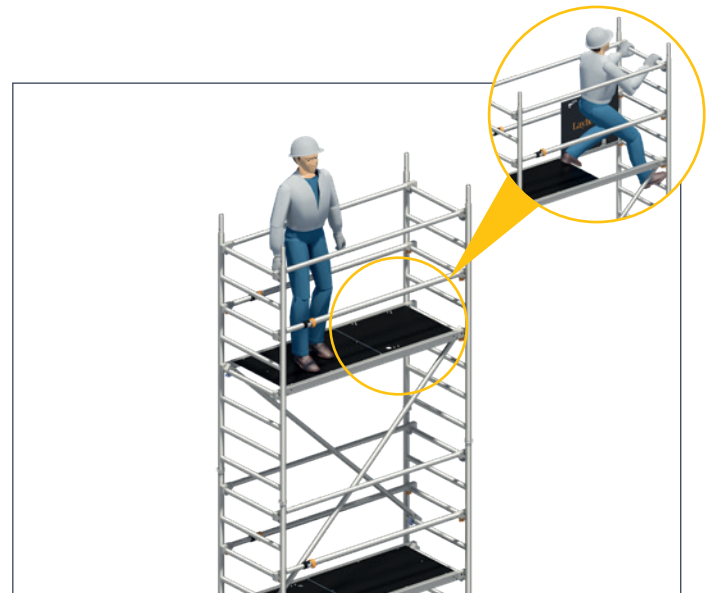

4. Access to the now secured level.

3.2.2 TOWER MODELS

1413202 – 1413207

For **assembly outdoors**, comply with the height restriction!

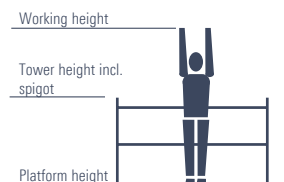

1403201: no Safety Structure P2 required – see Section 3.2



1413202



1413203



1413204



1413205



1413206



1413207

Tower model	1413202	1413203	1413204	1413205	1413206	1413207
Working height [m]	4.26	5.26	6.26	7.26	8.26	9.26
Tower height [m]	3.49	4.49	5.49	6.49	7.49	8.49
Platform height [m]	2.26	3.26	4.26	5.26	6.26	7.26
Weight [kg] (without ballast)	139.0	168.7	190.5	220.2	242.0	271.7
Ballasting (stated in units)						
Indoors						
Assembly, central	0	0	l2 r2	l3 r3	l5 r5	l6 r6
Assembly, off-centre	0	L0 R2	L0 R4	L0 R6	L2 R8	L2 R10
Assembly, off-centre with wall bracing	0	0	L2 R2	L4 R2	L6 R4	L6 R6
Outdoors						
Assembly, central	0	0	l3 r3	l5 r5	l9 r9	l13 r13
Assembly, off-centre	0	L0 R4	L0 R6	L0 R10	L4 R14	X
Assembly, off-centre with wall bracing	0	0	L4 R2	L6 R4	L10 R8	X

X = not permissible / not possible 0 = no ballast required For ballasting, use Layher ballast weights, Ref. No. 1249.000, of 10 kg each.

The weights are fastened quickly and securely at the right place using the handwheel coupler. All heights stated without possible spindle extension! The max. spindle extension of the relevant assembly variants can be found in the corresponding section! **Do not use any liquid or granular ballast substances. The ballast weights must be distributed evenly to all ballasting fixing points.**

Example: l2, r2 → Fasten 2 ballast weights of 10 kg each to the ladder frame on its left-hand side, and 2 ballast weights of 10 kg each on its right-hand side.

L6, R16 → Fasten 6 ballast weights of 10 kg each to the mobile beam on its left-hand side, and 16 ballast weights of 10 kg each on its right-hand side

In the case of off-centre assembly, r and R always relate to the side facing away from the tower; l and L relate to the side facing the tower.

1413122 – 1413227

with Uni telescoping guardrail and stabilisers, extendible

For **assembly outdoors**, comply with the height restriction!

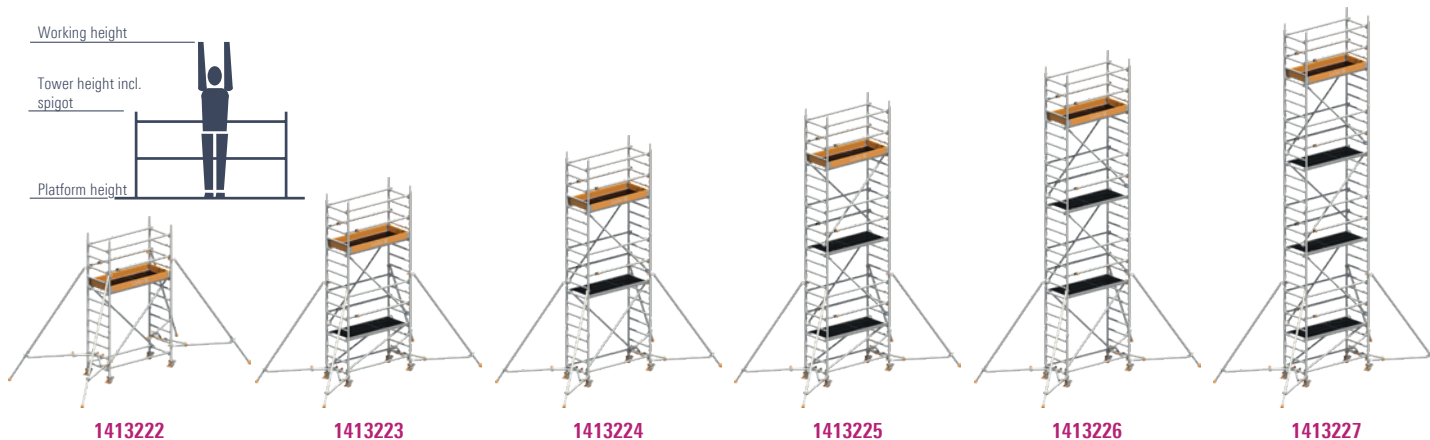

Tower model	1413222	1413223	1413224	1413225	1413226	1413227
Working height [m]	4.10	5.10	6.10	7.10	8.10	9.10
Tower height [m]	3.33	4.33	5.33	6.33	7.33	8.33
Platform height [m]	2.10	3.10	4.10	5.10	6.10	7.10
Weight [kg] (without ballast)	133.6	174.3	185.1	225.8	236.6	277.3
Ballasting (stated in units)						
Indoors						
Assembly, central	0	0	0	0	l2 r2	l2 r2
Assembly, off-centre	0	LO R4	LO R8	LO R10	LO R12	LO R14
Assembly, off-centre with wall bracing	0	0	0	0	0	0
Outdoors						
Assembly, central	0	0	0	l3 r3	l6 r6	l8 r8
Assembly, off-centre	0	LO R6	LO R10	LO R14	X	X
Assembly, off-centre with wall bracing	0	0	0	0	0	l2 r0

X = not permissible / not possible 0 = no ballast required For ballasting, use Layher ballast weights, Ref. No. 1249.000, of 10 kg each. The weights are fastened quickly and securely at the right place using the handwheel coupler. All heights stated without possible spindle extension! The max. spindle extension of the relevant assembly variants can be found in the corresponding section! **Do not use any liquid or granular ballast substances. The ballast weights must be distributed evenly to all ballasting fixing points.**

Example: l2, r2 → Fasten 2 ballast weights of 10 kg each to the ladder frame on its left-hand side, and 2 ballast weights of 10 kg each on its right-hand side.
 l6, R16 → Fasten 6 ballast weights of 10 kg each to the mobile beam on its left-hand side, and 16 ballast weights of 10 kg each on its right-hand side
 In the case of off-centre assembly, r and R always relate to the side facing away from the tower; l and L relate to the side facing the tower.

3.2.3 PARTS LIST

Safety Structure P2 with Uni Telescoping Guardrail, tower models 1413202 – 1413207

Tower model	Ref. No.	1413202	1413203	1413204	1413205	1413206	1413207
Uni telescoping guardrail	1204.180	2	4	4	6	6	8
Guardrail 1.80 m	1205.180	2	5	4	7	6	9
Double guardrail 1.80 m	1206.180	0	0	0	0	0	0
Diagonal brace 2.50 m	1208.180	2	2	4	4	6	6
Diagonal brace 1.95 m	1208.195	0	2	0	2	0	2
Basic tube 1.80 m	1211.180	1	1	1	1	1	1
Deck 1.80 m	1241.180	1	0	1	0	1	0
Access deck 1.80 m	1242.180	1	2	2	3	3	4
Spring clip	1250.000	8	8	12	12	16	16
Ladder frame 75/4 - 1.00 m	1297.004	2	0	2	0	2	0
Ladder frame 75/8 - 2.00 m	1297.008	2	4	4	6	6	8
Uni assembly hook	1300.010	1	1	1	1	1	1
Wheel 400, D=150 mm	1301.150	4	4	4	4	4	4
Mobile beam with bar	1323.180	2	2	2	2	2	2
End toe board	1438.075	2	2	2	2	2	2
Toe board with claw	1439.180	2	2	2	2	2	2
Ballast	1249.000	Number of ballast weights, see Section 3.2.2: Tower models					

Safety Structure P2 with Uni Telescoping Guardrail with stabiliser, extendable Tower models 1413222 – 1413227

Tower model	Ref. No.	1413222	1413223	1413224	1413225	1413226	1413227
Uni telescoping guardrail	1204.180	2	4	4	6	6	8
Guardrail 1.80 m	1205.180	4	6	6	8	8	10
Diagonal brace 2.50 m	1208.180	2	2	4	4	6	6
Diagonal brace 1.95 m	1208.195	0	2	0	2	0	2
Access deck 1.80 m	1242.180	1	2	2	3	3	4
Stabiliser, extendible	1248.260	4	4	4	4	4	4
Rotation lock for stabiliser	1248.261	4	4	4	4	4	4
Spring clip	1250.000	4	4	8	8	12	12
Ladder frame	1297.004	2	0	2	0	2	0
Ladder frame	1297.008	2	4	4	6	6	8
Uni assembly hook	1300.010	1	1	1	1	1	1
Wheel 400, D=150 mm	1301.150	4	4	4	4	4	4
End toe board	1438.075	2	2	2	2	2	2
Toe board with claw	1439.180	2	2	2	2	2	2
Ballast	1249.000	Number of ballast weights, see Section 3.2.2: Tower models					

3.2.4 ASSEMBLY SEQUENCE SAFETY STRUCTURE P2 WITH UNI TELESCOPING GUARDRAIL

Observe the general directions for assembly and use on pages 5 – 7. The assembly examples shown are intended for use up to a maximum platform height of 12 m indoors and up to a maximum platform height of 8 m outdoors. Unless explicitly stated in the text, snap-on claws should generally be snapped onto the ladder frames from above. Level the scaffolding structure after basic assembly. This is done using the threaded spindles of the wheels.



The wheels must be locked during assembly, modification or dismantling and while there is anybody on the scaffolding structure.

Hammer home the wedges in the system until the blow bounces off. Always tighten the screw couplers well (50 Nm).

At the top level, instead of two guardrails **20**, it is also possible to fit a double guardrail **21** or a tower beam **24**. Please remember in this case that two additional guardrails **20** and two additional Uni telescoping guardrails **23** must be provided for assembly and dismantling in order to ensure collective two-part side protection. These can be removed again after inserting the double guardrails **21** or the tower beams **24**.

The **item numbers** for the components relate to the component list on pages 53 – 56.

BASIC ASSEMBLY Tower models 1413202, 1413204 and 1413206



1. Insert the castors **1** into the mobile beams **8/9** and secure them against falling out with the associated bolts and nuts.
2. The mobile beams **8/9** must be connected with a basic tube **12** – or optionally with a basic strut **13** – and a deck **30**.
3. Fit two ladder frames 75/4 **17** on the mobile beams and secure using spring clips **19**.

Further assembly is performed as per page 30, “Assembly of intermediate platforms”.

BASIC ASSEMBLY

Tower models
1413203,
1413205 and
1413207



1. Insert the castors **1** into the mobile beams **8/9** and secure them against falling out with the associated bolts and nuts.
2. The mobile beams **8/9** must be connected to one another with a basic tube **12** – or optionally with a basic strut **13** – and a guardrail **20** at the access ledger of the mobile beam.
3. Fit a ladder frame **75/8 18** on the mobile beam **8/9** and secure it using spring clips **19**. Hook in two guardrails **20** at the topmost rung and connect to a second ladder frame **75/8 18**. Hook in two Uni telescoping guardrails **23**, both two rungs below the guardrails **20**, and connect these to the second ladder frame **75/8 18** at the corresponding rung. Then swivel the second ladder frame **75/8 18** upwards, mount it on the mobile beam and secure it with spring clips **19**.

*Any double guardrails **21** that might be in stock should be installed as side protection for the first platform. In this case, assembly can be performed from the assembly surface (floor) with ladder frames **75/8 18** mounted on both sides.*

4. Fit two diagonal braces **26** and an access deck **31**. **Ensure that the two diagonal braces are installed parallel to one another in the direction of the access hatch.**

Further assembly is performed as per page 30, "Assembly of intermediate platforms".

BASIC ASSEMBLY

Tower models
1413222,
1413224 and
1413226



1. Insert the castors **1** in the ladder frames **75/4 17** and secure them against falling out using the associated bolts and nuts.
2. Mount a ladder frame **75/8 18** on one side and secure it with spring clips **19**. To brace the structure, install the first diagonal brace **25** from the fourth rung from the bottom of ladder frame **75/8 18** to the bottommost rung of the ladder frame **75/4 17** opposite.
3. Hook in two guardrails **20** at the topmost rung and connect to a second ladder frame **75/8 18**. Hook in two Uni telescoping guardrails **23**, both two rungs below the guardrails **20**, and connect these to the second ladder frame **75/8 18** at the corresponding rung. Then swivel the second ladder frame **75/8 18** upwards, mount it on the second ladder frame **75/4 17** and secure it using spring clips **19**.
4. Hook in the access deck **31** and install the second diagonal brace **25** crosswise to the one that is already installed. Assemble two guardrails **20** at the bottom rung of the ladder frame **75/4 17**.
5. To maintain the maximum distance from the first rung, fit an access ledger **14** on the ascent side of the rolling tower.

Further assembly is performed as per page 30, "Assembly of intermediate platforms".

Further assembly for model 1413222 is performed as per p. 31 "Completing the working platform".

BASIC ASSEMBLY

Tower models

1413223,
1413225 and
1413227



1. Insert the castors **1** in the ladder frames 75/8 **18** and secure them against falling out using the associated bolts and nuts.
2. Position a ladder frame 75/8 **18**, hook in two guardrails **20** at the topmost rung and connect to a second ladder frame 75/8 **18**. Hook in two Uni telescoping guardrails **23**, both two rungs below the guardrails **20**, and connect these to the second ladder frame 75/8 **18** at the corresponding rung. Then position the second ladder frame 75/8 **18** parallel to the first ladder frame and brace them in the same direction by means of the two short diagonal braces **26**. **Ensure that the two diagonal braces are installed parallel to one another in the direction of the access hatch.**

*Any double guardrails **21** that might be in stock should be installed as side protection for the first platform. In this case, assembly can be performed from the assembly surface (ground) with the ladder frames fitted on both sides.*

3. Fit two guardrails **20** to the bottom rung of the ladder frames and an access deck **31** to the fourth rung from the bottom.
4. To maintain the maximum distance from the first rung, fit an access ledger **14** on the ascent side of the rolling tower.

Further assembly is performed as per page 30, "Assembly of intermediate platforms".

ASSEMBLY OF INTERMEDIATE PLATFORMS

All tower models with Safety Structure P2 with Uni telescoping guardrail

i Repeat the following assembly steps 1 to 5 several times depending on the assembly height.

1. Mount the first ladder frame 75/8 **18** and secure using spring clips **19**.



2. Attach the Uni assembly hooks **32** and position the second ladder frame 75/8 **18**. Hook in two guardrails **20**, each at the top rung of the corresponding mounted ladder frame 75/8 **18** and connect it to a second ladder frame 75/8 **18**. Hook in two Uni telescoping guardrails **23**, both two rungs below the guardrails **20**, and connect these to the second ladder frame 75/8 **18** at the corresponding rung.



3. Swivel the second ladder frame 75/8 **18** together with the pre-assembled side protection upwards and secure using spring clips **19**.



4. Insert both diagonal braces **25** and the access deck **31**.

*Make sure that the diagonal braces **25** cross over one another and ascend as a tower-like structure (in a zigzag) on both sides.*



5. Move onto the next platform up, which is already completely secured by means of two-part side protection.

COMPLETING THE WORKING PLATFORM

All tower models for creating the required working platform

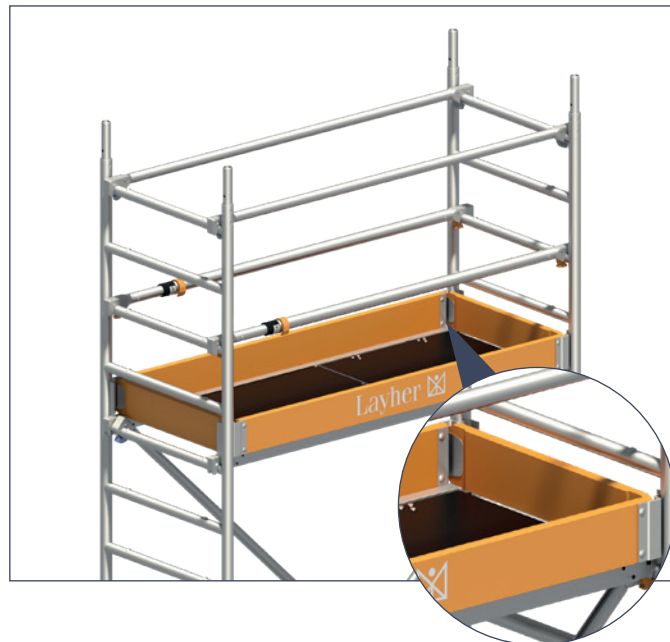

To complete the working platform, attach toe boards with claw **33** and end toe boards **34**.



If an intermediate platform is used as a working platform, it is also necessary to attach toe boards here.

3.2.5 ASSEMBLY SEQUENCE SAFETY STRUCTURE P2 WITH UNI TELESCOPING GUARDRAIL

 Repeat the following dismantling steps 1 to 6 several times depending on the assembly height.

Dismantling is performed in the reverse order to assembly.

When dismantling, do not remove the bracing elements such as diagonal braces, guardrails or access decks until the ladder frames above them have been dismantled.

To lift out the individual parts, open the snap-on claws by pressing their locking clips.

1. Dismantle the toe boards **33/34** (only necessary on the working platform).
2. Before coming down, make sure that the plastic spring clips of the Uni telescoping guardrails **23** are released so that the guardrail is able to telescope (see detailed images).

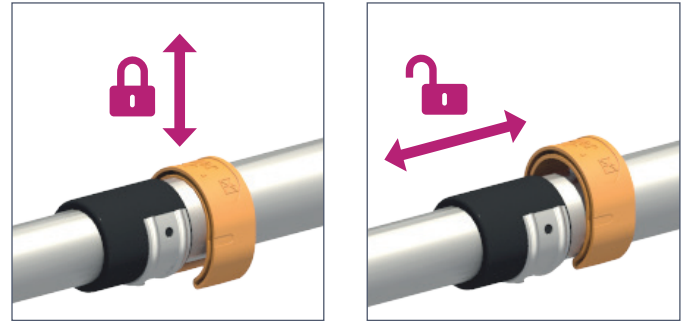

3. After climbing down to the platform underneath, dismantle the access deck **31** and the diagonal braces **25**.
4. Attach the Uni assembly hooks **32** on one side and remove the spring clips **19** on the same side.



5. Lift out the ladder frame 75/8 **18** on the Uni assembly hook side, swing downwards together with the still assembled side protection and position in the assembly hooks **27**.

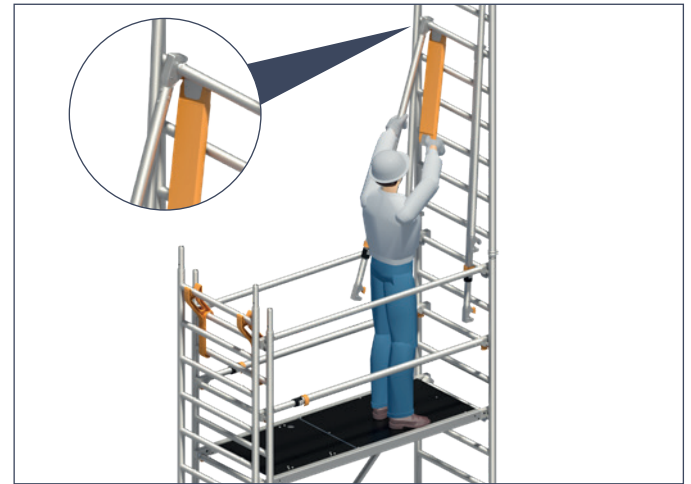

6. Dismantling the side protection. Release all the snap-on claws of the Uni telescoping guardrails **23** and the guardrails **20** from the rungs of the ladder frame 75/8 **18** on the side positioned in the Uni assembly hooks **32**. All guardrails can be placed suspended at the opposite ladder frame 75/8 **18** and remain there until the ladder frame positioned in the assembly hook **27** has been secured against falling out or tipping over. The side protection can then be completely dismantled. Using an end toe board **34** or an additionally available guardrail **20** to act as an extension, first release the locking clips of the snap-on claws from the Uni Telescoping Guardrails **23** about 2.5 metres up in order to lift out the snap-on claw from the rungs. Next, dismantle the guardrail **20** fitted above it in the same way.



3.3 ROLLING TOWERS WITH SAFETY STRUCTURE P2 SAFETY^{PLUS} WITH DOUBLE GUARDRAIL

3.3.1 FALL PROTECTION MEASURES

Suitable measures for fall protection must be taken during assembly, modification or dismantling of the scaffolding structure. Safety Structure P2 SAFETY^{PLUS} with double guardrail implements these protective measures in full.

Safety Structure P2 SAFETY^{PLUS}

with double guardrail

- ▶ Platforms with a vertical spacing of 2 m.
- ▶ Safer design with integrated, collective and advancing side protection.

Thanks to the platforms, which are assembled 2-m apart, the necessary side protection can only be assembled and dismantled from the already secured level below. There is no other way of performing these operations, meaning that when personnel access and leave the next platform up, this already has two-part side protection on all sides.





1. Attach the first ladder frame. Attach the Uni assembly hooks and position the second ladder frame in order to fit the double guardrail on both sides.



2. Swivel the ladder frame with double guardrail upwards and fit it on the ladder frame below.

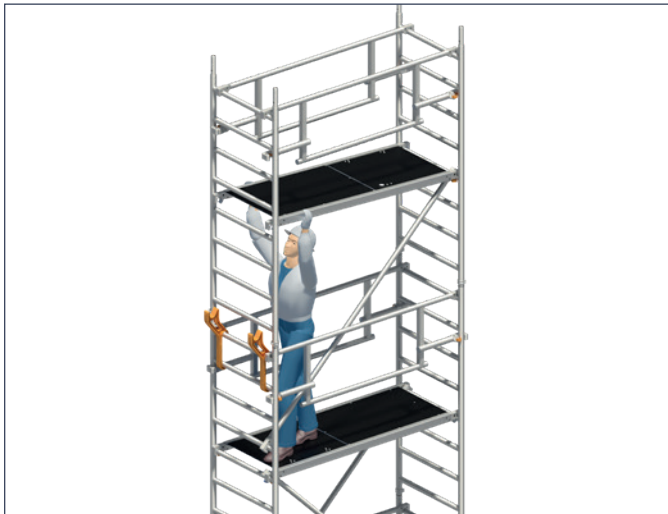

3. Insert diagonal braces and access deck.



4. Move up to the already secured level and finish by snapping the dual guardrail (lower snap-on claws) into the ladder frame.

3.3.2 TOWER MODELS

1423201 – 1423207

For **assembly outdoors**, comply with the height restriction!

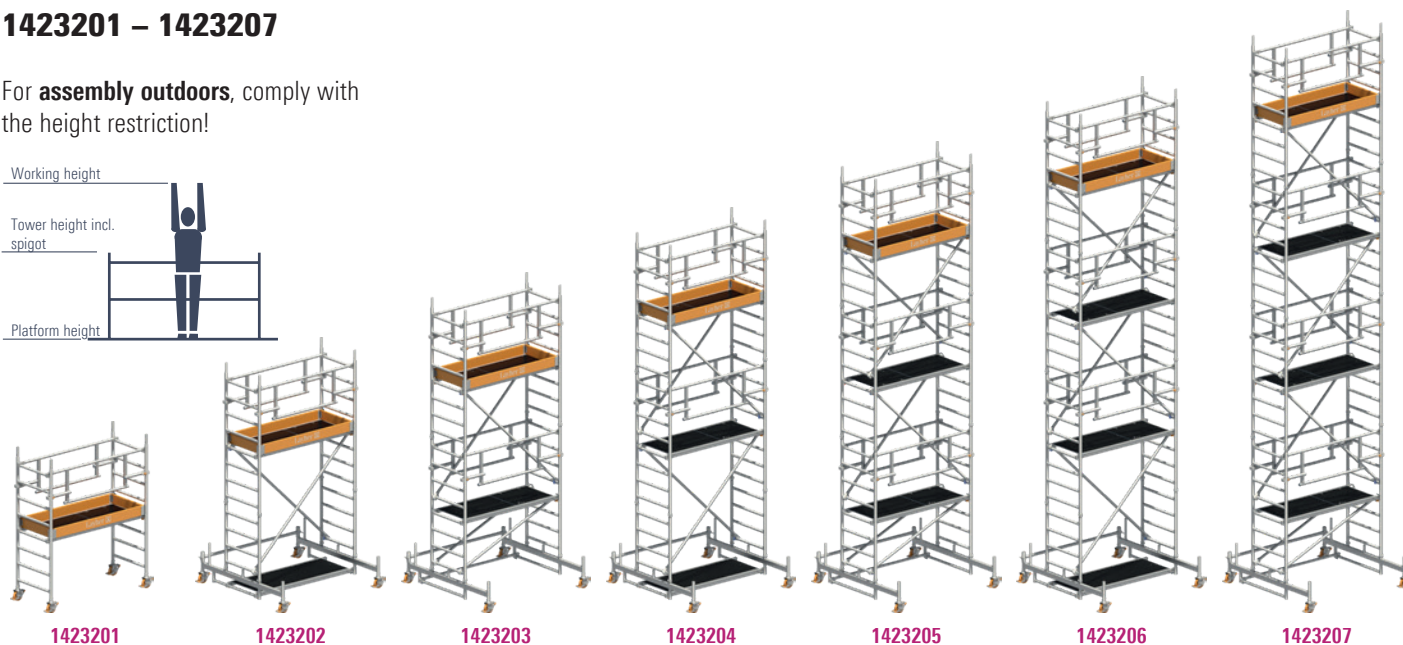
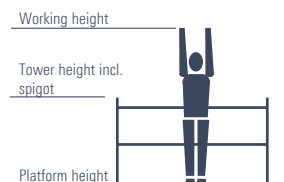

Tower model	1423201	1423202	1423203	1423204	1423205	1423206	1423207
Working height [m]	3.11	4.26	5.26	6.26	7.26	8.26	9.26
Tower height [m]	2.34	3.49	4.49	5.49	6.49	7.49	8.49
Platform height [m]	1.11	2.26	3.26	4.26	5.26	6.26	7.26
Weight [kg] (without ballast)	66.7	139.5	169.7	191.5	221.7	243.5	273.7
Ballasting (stated in units)							
Indoors							
Assembly, central	14 r4	0	0	12 r2	13 r3	15 r5	16 r6
Assembly, off-centre	X	0	L0 R2	L0 R4	L0 R6	L2 R8	L2 R10
Assembly, off-centre with wall bracing	X	0	0	L2 R2	L4 R2	L6 R4	L6 R6
Outdoors							
Assembly, central	14 r4	0	13 r3	15 r5	19 r9	113 r13	X
Assembly, off-centre	X	L0 R4	L0 R6	L0 R10	L4 R14	L8 R20	X
Assembly, off-centre with wall bracing	X	0	L4 R2	L6 R4	L10 R8	L16 R10	X

X = not permissible / not possible 0 = no ballast required For ballasting, use Layher ballast weights, Ref. No. 1249.000, of 10 kg each.

The weights are fastened quickly and securely at the right place using the handwheel coupler. All heights stated without possible spindle extension! The max. spindle extension of the relevant assembly variants can be found in the corresponding section! **Do not use any liquid or granular ballast substances. The ballast weights must be distributed evenly to all ballasting fixing points.**

Example: L2, r2 → Fasten 2 ballast weights of 10 kg each to the ladder frame on its left-hand side, and 2 ballast weights of 10 kg each on its right-hand side.
L6, R16 → Fasten 6 ballast weights of 10 kg each to the mobile beam on its left-hand side, and 16 ballast weights of 10 kg each on its right-hand side.
In the case of off-centre assembly, r and R always relate to the side facing away from the tower; l and L relate to the side facing the tower.

1423222 – 1423227

with double guardrail and stabilisers, extendible

For **assembly outdoors**, comply with the height restriction!

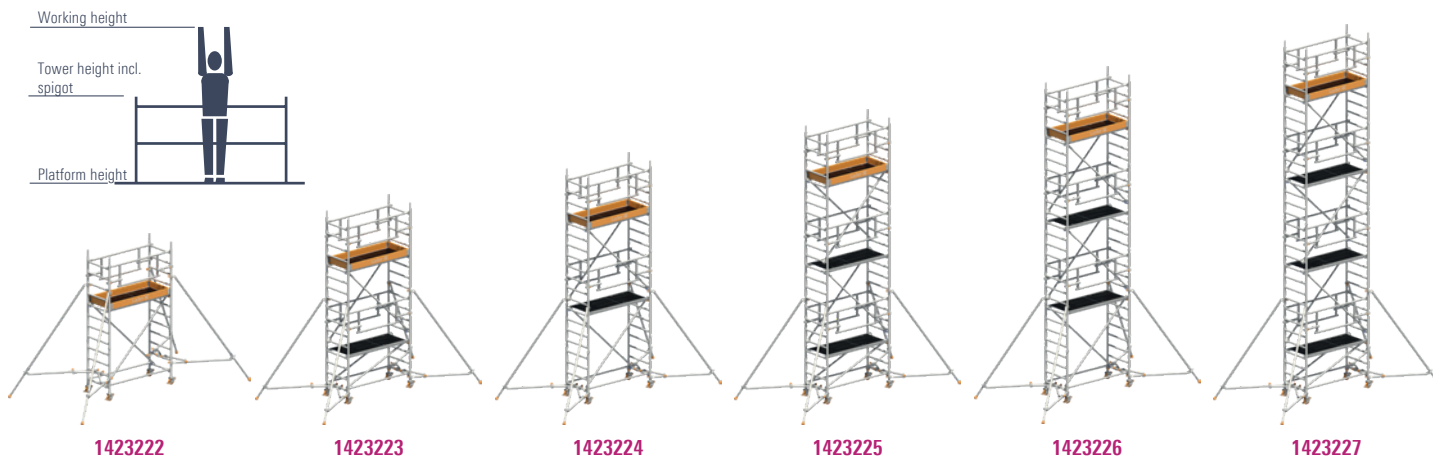

Tower model	1423222	1423223	1423224	1423225	1423226	1423227
Working height [m]	4.10	5.10	6.10	7.10	8.10	9.10
Tower height [m]	3.33	4.33	5.33	6.33	7.33	8.33
Platform height [m]	2.10	3.10	4.10	5.10	6.10	7.10
Weight [kg] (without ballast)	134.1	175.3	186.1	227.3	238.1	279.3
Ballasting (stated in units)						
Indoors						
Assembly, central	0	0	0	0	l2 r2	l2 r2
Assembly, off-centre	0	LO R4	LO R8	LO R10	LO R12	LO R14
Assembly, off-centre with wall bracing	0	0	0	0	0	0
Outdoors						
Assembly, central	0	0	l3 r3	l6 r6	l8 r8	X
Assembly, off-centre	LO R6	LO R10	LO R14	X	X	X
Assembly, off-centre with wall bracing	0	0	0	0	l2 r0	X

X = not permissible / not possible 0 = no ballast required For ballasting, use Layher ballast weights, Ref. No. 1249.000, of 10 kg each. The weights are fastened quickly and securely at the right place using the handwheel coupler. All heights stated without possible spindle extension! The max. spindle extension of the relevant assembly variants can be found in the corresponding section! **Do not use any liquid or granular ballast substances. The ballast weights must be distributed evenly to all ballasting fixing points.**

Example: l2, r2 → Fasten 2 ballast weights of 10 kg each to the ladder frame on its left-hand side, and 2 ballast weights of 10 kg each on its right-hand side.
 l6, R16 → Fasten 6 ballast weights of 10 kg each to the mobile beam on its left-hand side, and 16 ballast weights of 10 kg each on its right-hand side
 In the case of off-centre assembly, r and R always relate to the side facing away from the tower; l and L relate to the side facing the tower.

3.3.3 PARTS LIST

Safety Structure P2 SAFETY^{PLUS} with double guardrail, tower models 1423201 – 1423207

Tower model	Ref. No.	1423201	1423202	1423203	1423204	1423205	1423206	1423207
Guardrail 1.80 m	1205.180	0	0	1	0	1	0	1
Diagonal brace 2.50 m	1208.180	0	2	2	4	4	6	6
Diagonal brace 1.95 m	1208.195	0	0	2	0	2	0	2
Basic tube 1.80 m	1211.180	0	1	1	1	1	1	1
Safety double guardrail	1216.180	2	2	4	4	6	6	8
Deck 1.80 m	1241.180	0	1	0	1	0	1	0
Access deck 1.80 m	1242.180	1	1	2	2	3	3	4
Spring clip	1250.000	0	8	8	12	12	16	16
Ladder frame 75/4 - 1.00 m	1297.004	0	2	0	2	0	2	0
Ladder frame 75/8 - 2.00 m	1297.008	2	2	4	4	6	6	8
Uni assembly hook	1300.010	0	1	1	1	1	1	1
Castor 400, D=150 mm	1301.150	4	4	4	4	4	4	4
Mobile beam with bar	1323.180	0	2	2	2	2	2	2
End toe board	1438.075	2	2	2	2	2	2	2
Toe board with claw	1439.180	2	2	2	2	2	2	2
Ballast	1249.000	For number of ballast weights, see Section 3.3.2: Tower models						

Safety Structure P2 SAFETY^{PLUS} with double guardrail with stabiliser, extendable Tower models 1423222 – 1423227

Tower model	Ref. No.	1423222	1423223	1423224	1423225	1423226	1423227
Guardrail 1.80 m	1205.180	2	2	2	2	2	2
Diagonal brace 2.50 m	1208.180	2	2	4	4	6	6
Diagonal brace 1.95 m	1208.195	0	2	0	2	0	2
Safety double guardrail	1216.180	2	4	4	6	6	8
Access deck 1.80 m	1242.180	1	2	2	3	3	4
Stabiliser, extendible	1248.260	4	4	4	4	4	4
Rotation lock for stabiliser	1248.261	4	4	4	4	4	4
Spring clip	1250.000	4	4	8	8	12	12
Ladder frame 75/4 - 1.00 m	1297.004	2	0	2	0	2	0
Ladder frame 75/8 - 2.00 m	1297.008	2	4	4	6	6	8
Uni assembly hook	1300.010	1	1	1	1	1	1
Castor 400, D=150 mm	1301.150	4	4	4	4	4	4
End toe board	1438.075	2	2	2	2	2	2
Toe board with claw	1439.180	2	2	2	2	2	2
Ballast	1249.000	For number of ballast weights, see Section 3.3.2: Tower models					

3.3.4 ASSEMBLY SEQUENCE SAFETY STRUCTURE P2 SAFETY^{PLUS} WITH DOUBLE GUARDRAIL

Observe the general directions for assembly and use on pages 5 – 7. The assembly examples shown are intended for use up to a maximum platform height of 12 m indoors and up to a maximum platform height of 8 m outdoors. The snap-on claws of the parts should generally be fully engaged. Level the scaffolding structure after basic assembly. This is done using the threaded spindles of the wheels.



The wheels must be locked during assembly, modification or dismantling and while there is anybody on the scaffolding structure.

Hammer home the wedges in the system until the blow bounces off. Always tighten the screw couplers well (50 Nm).

The **item numbers** for the components relate to the component list on pages 53 – 56.

BASIC ASSEMBLY Tower models 1423201



1. Insert the castors **1** in the ladder frames 75/8 **18** and secure them against falling out using the associated bolts and nuts.
2. Position a ladder frame 75/8 **18**, hook two safety double guardrails **22** onto the topmost rung using the snap-on housings at the top handrail and connect to a second ladder frame 75/8 **18** that has previously been positioned on the opposite side at an angle to the outside, again at the topmost rung.

In each case, make sure that the claws come up against the rung's shift preventer on the inside (bulge on the top side of the rung) in order to allow the lower claws to swivel freely.

Then swivel the second ladder frame 75/8 **18** inwards at the bottom parallel to the first ladder frame and into position so that the lower guardrail claws can be snapped on at the upright tubes.

3. Hook the access deck **31** into the fourth rung from the bottom of the ladder frames 75/8 **18**.

Further assembly is performed as per page 45, "Completing the working platform".

BASIC ASSEMBLY

Tower models
1423202,
1423204 and
1423206



1. Insert the castors **1** into the mobile beams **8/9** and secure them against falling out with the associated bolts and nuts.
2. The mobile beams **8/9** must be connected with a basic tube **12** – or optionally with abasic strut **13** – and a deck **30**.
3. Fit two ladder frames 75/4 **17** on the mobile beams and secure using spring clips **19**.

Further assembly is performed as per page 44, “Assembly of intermediate platforms”.

BASIC ASSEMBLY

Tower models
1423203,
1423205 and
1423207



1. Insert the castors **1** into the mobile beams **8/9** and secure them against falling out with the associated bolts and nuts.
2. The mobile beams **8/9** must be connected to one another with a basic tube **12** – or optionally with a basic strut **13** – and a guardrail **20** at the access ledger of the mobile beam.
3. Fit a ladder frame 75/8 **18** on the mobile beam **8/9** and secure it using spring clips **19**. Hook two safety double guardrails **22** onto the topmost rung using the snap-on housings at the top handrail and connect to a second ladder frame 75/8 **18** that has previously been positioned on the opposite side at an angle to the outside, again at the topmost rung.

In each case, make sure that the claws come up against the rung's shift preventer on the inside (bulge on the top side of the rung) in order to allow the lower claws to swivel freely.

Then swivel the second ladder frame 75/8 **18** upwards and fit into the spigots of the mobile beam **8/9**.

4. Fit two diagonal braces **26** and the access deck **31**. **Ensure that the two diagonal braces are installed parallel to one another in the direction of the access hatch.**
5. Move up and onto the next platform up, which is already completely secured by means of two-part side protection. Fix the safety double guardrail **22** by pressing gently towards the outside in order to engage the lower claws in the upright tube of the ladder frames.

Further assembly is performed as per page 44, "Assembly of intermediate platforms".

BASIC ASSEMBLY

Tower models
1423222,
1423224 and
1423226



1. Insert the castors **1** in the ladder frames 75/4 **17** and secure them against falling out by tightening the wing screws on the spindle nuts.
2. Mount a ladder frame 75/8 **18** on a ladder frame 75/4 **17** and secure it using spring clips **19**. Hook two safety double guardrails **22** onto the topmost rung using the snap-on housings at the top handrail and connect to a second ladder frame 75/8 **18** that has previously been positioned on the opposite side at an angle to the outside, again at the topmost rung.
3. Fit two diagonal braces **25** crosswise. Assemble two guardrails **20** at the bottom rung of the ladder frame 75/4 **17** and then hook in an access deck **31**.
4. To maintain the maximum distance from the first rung, fit an access ledger **14** on the ascent side of the rolling tower.
5. Move up and onto the next platform up, which is already completely secured by means of two-part side protection. Fix the safety double guardrail **22** by pressing gently towards the outside in order to engage the lower claws in the upright tube of the ladder frames.

In each case, make sure that the claws come up against the rung's shift preventer on the inside (bulge on the top side of the rung) in order to allow the lower claws to swivel freely.

Then swivel the second ladder frame 75/8 **18** upwards and into the spigots of the ladder frame 75/4 **17** and secure using spring clips **19**.

Further assembly is performed as per page 45, "Assembly of intermediate platforms". Further assembly for model 1423222 is performed as per p. 45 "Completing the working platform".

BASIC ASSEMBLY

Tower models
1423223,
1423225 and
1423227



1. Insert the castors **1** in the ladder frames 75/8 **18** and secure them against falling out by tightening the wing screws on the spindle nuts.
2. Position a ladder frame 75/8 **18**, hook two safety double guardrails **22** onto the topmost rung using the snap-on housings at the top handrail and connect to a second ladder frame 75/8 **18** that has previously been positioned on the opposite side at an angle to the outside, again at the topmost rung.

In each case, make sure that the claws come up against the rung's shift preventer on the inside (bulge on the top side of the rung) in order to allow the lower claws to swivel freely.
3. Hook the access deck **31** into the fourth rung from the bottom of the ladder frames 75/8 **18**. Fit two diagonal braces **26** in the same direction. **Ensure that the two diagonal braces are installed parallel to one another in the direction of the access hatch.** Assemble two guardrails **20** at the bottom rung of the ladder frame 75/8 **18** and then hook in an access deck **31**.
4. To maintain the maximum distance from the first rung, fit an access ledger **14** on the ascent side of the rolling tower.
5. Move up and onto the next platform up, which is already completely secured by means of two-part side protection. Fix the safety double guardrail **22** by pressing gently towards the outside in order to engage the lower claws in the upright tube at the ladder frames.

Then swivel the second ladder frame 75/8 **18** inwards at the bottom parallel to the first ladder frame and into position so that the lower guardrail claws can be snapped on at the upright tubes.

Further assembly is performed as per page 44, "Assembly of intermediate platforms".

ASSEMBLY OF INTERMEDIATE PLATFORMS

All tower models with Safety Structure P2 SAFETY^{PLUS} with double guardrail

i Repeat the following assembly steps 1 to 5 several times depending on the assembly height.

1. Mount the first ladder frame 75/8 **18** and secure it using spring clips **19**.

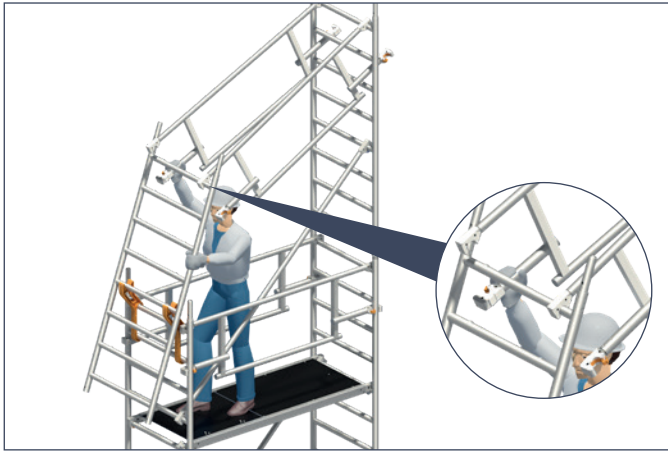

2. Attach the Uni assembly hooks **32** and position the second ladder frame 75/8 **18**. Fit a diagonal brace **25** rising from the ladder frame 75/8 **18** on the side of the Uni assembly hooks **32** to the already fitted ladder frame 75/8 **18**. Hook two safety double guardrails **22** with the snap-on housings at the top handrail in the top rung of the fitted ladder frame 75/8 **18** and connect them to the second ladder frame 75/8 **18**, which was previously positioned in the Uni assembly hook **32**, again at the top rung.

It must be ensured here that the claws each contact the inside of the shift preventer on the rung (bulge on the top of the rung) to allow the lower claws to swivel freely.



3. Swivel the ladder frame 75/8 **18** upwards out of its position in the Uni assembly hooks **32**, mount it and secure it using spring clips **19**.



4. Insert the second diagonal brace **25** and the access deck **31**.

*Make sure that the diagonal braces **25** cross over one another and ascend as a tower-like structure (in a zigzag) on both sides.*



5. Move up and onto the next platform up, which is already completely secured by means of two-part side protection. Fix the safety double guardrails **22** by pressing gently towards the outside in order to engage the lower claws in the upright tube at the ladder frames.

COMPLETING THE WORKING PLATFORM

All tower models for creating the required working platform



To complete the working platform, attach toe boards with claw **33** and end toe boards **34**.



If an intermediate platform is used as a working platform, it is also necessary to attach toe boards here.

3.3.5 DISMANTLING SEQUENCE SAFETY STRUCTURE P2 SAFETY^{PLUS} WITH DOUBLE GUARDRAIL

 Repeat the following dismantling steps 1 to 6 several times depending on the assembly height.

Dismantling is performed in the reverse order to assembly.

When dismantling, do not remove the bracing elements such as diagonal braces, guardrails or access decks until the ladder frames above them have been dismantled.

To lift out the individual parts, open the snap-on claws by pressing their locking clips.

1. Dismantle the toe boards **33/34** (only necessary on the working platform).
2. Before coming down, make sure that the fastening of the safety double guardrail **22** has been undone by releasing the lower claws at the upright tube of the ladder frame 75/8 **18**. This is easier if you lift it slightly when unlocking it. After releasing the fastening, position each of the safety double guardrails **22** with the upper claws inside at the rung's shift preventer (bulge at the top of the rung) again in order to allow the lower claws to swivel freely.



3. After climbing down to the platform below, attach the Uni assembly hooks **32** and you can remove the spring clips **19** above.
4. Dismantle the access deck **31** and the diagonal brace **25** that climbs upwards in the direction of the previously mounted Uni assembly hooks **32**.



5. Lift out the ladder frame 75/8 **18** on the Uni assembly hook side and swivel it downwards together with the two safety double guardrails **22** and then position it in the Uni assembly hooks **32**.



6. Lift the two safety double guardrails **22** out of the ladder frame **75/8 18** positioned in the Uni assembly hooks **32** and place down suspended on one side at the ladder frame **75/8 18** opposite. Secure the ladder frame positioned in the Uni assembly hooks **32** against falling or tipping and then remove the safety double guardrail **22** from its suspended position. Dismantle the second diagonal brace **25** so that the ladder frame **75/8 18** that is still mounted can be removed.



4. CASTORS

OPERATING THE CASTOR

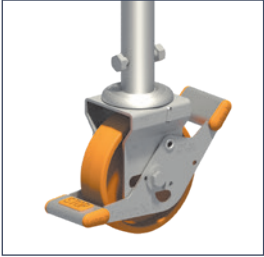

During assembly and while working, lock the castors by pressing down the brake lever labelled STOP. When the brake is locked, the lever labelled STOP must be in the down position. To move the structure, unlock the castors by pressing the opposite lever.

5. BALLASTING

Attachment of ballast weights

 Ballasting does not depend on the assembly variant, and applies for the tower models stated in each case. The figures are shown by way of example and refer to Safety Structure P2.

Assembly, central:

Models:
1403201
1423201

Models:
1403202 – 1403207
1413202 – 1413207
1423202 – 1423207

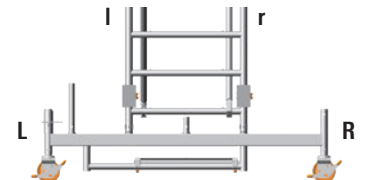
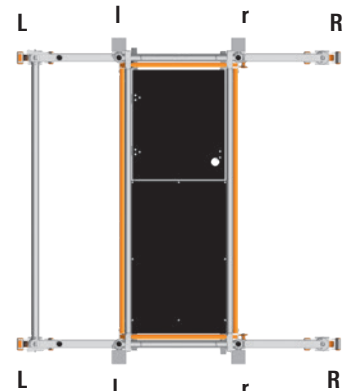
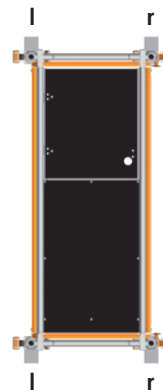



When attaching large numbers of the ballast weights required in any given case, it is possible that additional tubular components with a tube diameter of 48.3 mm may be needed as extensions at or in close proximity to the fixing points. These components (e.g. Uni distance tube, couplers, basic strut or basic tube) are not counted in the number of ballast weights in the model description or the parts lists and must be taken into account for the respective model and associated assembly site and be included as part of the assembly.

Assembly, off-centre:

Models:

1403222 – 1403227

1413222 – 1413227

1423222 – 1423227

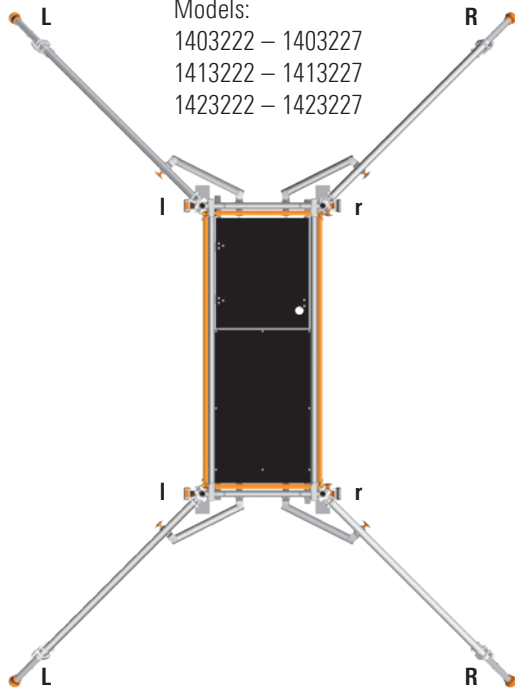

Models:

1403202 – 1403207

1413202 – 1413207

1423202 – 1423207

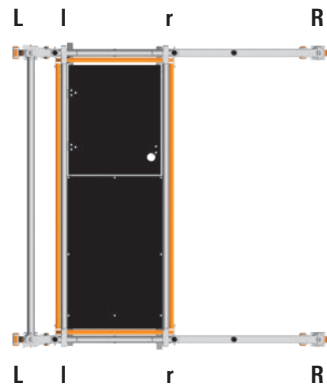

L

Models:

1403222 – 1403227

1413222 – 1413227

1423222 – 1423227

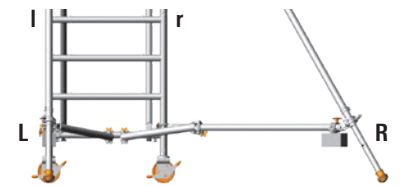
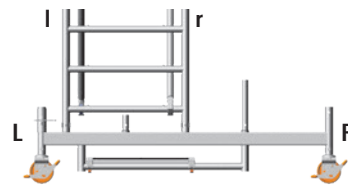
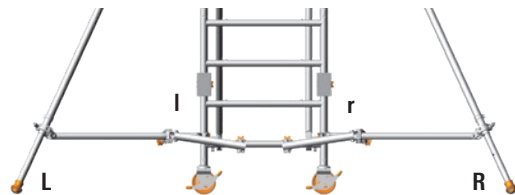
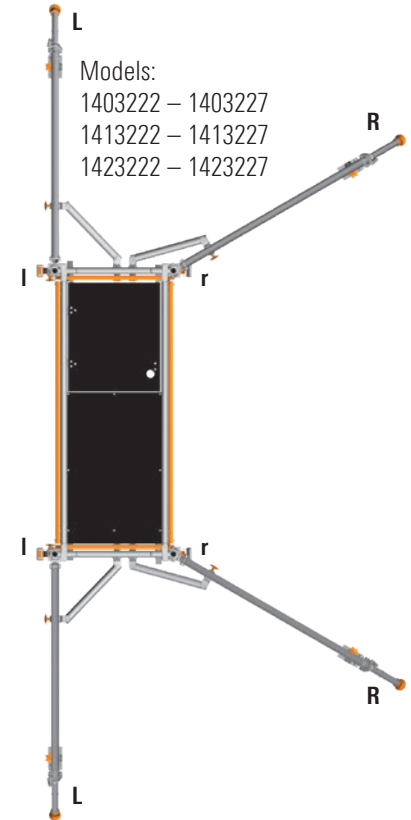

In the case of the side-mounted version with wall support, the support must always be fitted on the "L" side.

Example for assembly of model 1403204

Assembly outdoors in central position

Ballast: see page 10



Tower model	1403204
Working height [m]	6.26
Tower height [m]	5.48
Platform height [m]	4.26
Weight [kg] (without ballast)	181.5
Ballasting	
Indoors	
Assembly, central	I2 r2
Assembly, off-centre	L0 R4
Assembly, off-centre with wall bracing	L2 R2
Outdoors	
Assembly, central	I3 r3
Assembly, off-centre	L0 R6
Assembly, off-centre with wall bracing	L4 R2

 The ballasting is independent of the assembly variant. The figure is shown by way of example and refers to Safety Structure P2.

6. ATTACHING THE STABILISERS

Before assembly, please note Section "Basic assembly for rolling tower models without mobile beams". With this assembly form, the fixed and adjustable mobile beams are dispensed with. They are replaced by extendable stabilisers.



The attachment of the stabilisers is independent of the assembly variant. The figures are shown by way of example and refer to Safety Structure P2.

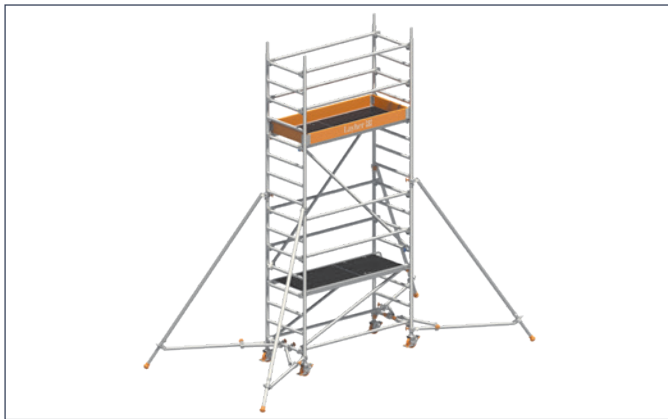

Attach a stabiliser **35** to each stile of the ladder frame **17/18** as follows. Position the upper half-coupler of the stabiliser **35** at the appropriate height on the ladder frame **17/18**. Then, before finally tightening the handwheels, position the transverse tube by means of the half-coupler, also at the appropriate height on the ladder frame **17/18**. After alignment of the stabilisers in the correct position (against wall or free-standing) and ensuring a firm stand on the ground, tighten the half-couplers using the handwheels. It must be ensured that the spring clips safely engage in the telescoping parts of the extendable stabiliser.

Set the alignment of the stabilisers as follows:

Free-standing assembly:

in each case about 60° to the tower longitudinal side (Fig. left).

Assembly against a wall

On the wall side about 90° to the tower end face.

Side facing away from the wall about 60° to the tower longitudinal side (Fig. right).

The specified angles can be checked after attachment of the stabilisers on the basis of the length dimensions "Spacing L". To ensure that the position of the stabilisers cannot change, for example due to inadvertent rotation, attach the tower rotation lock **36** to the stabiliser **35**. Position the tower rotation lock between the ladder frame and the stabiliser **35** such that one half-coupler is fastened to the transverse tube of the stabiliser and the second half-coupler to the ladder frame rung. After positioning, tighten the half-couplers using the handwheels. When moving the Mobile Working Platform, do not lift the stabiliser more than 2 cm off the ground.

Correct ballasting of the individual models is specified in the table for ballasting (see page 11). For work performed on a load-bearing wall, wall bracing can be fitted on both sides of the tower, allowing a reduction of the ballasting in accordance with the table (see page 11).

Free-standing assembly

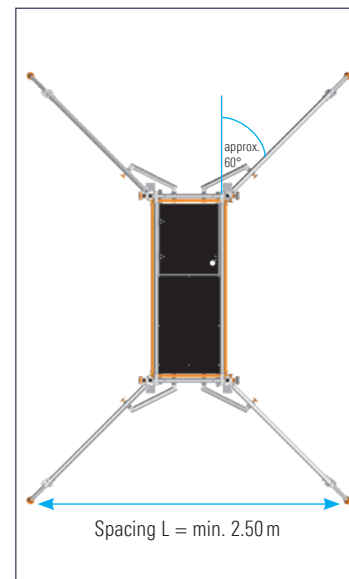

Assembly against a wall

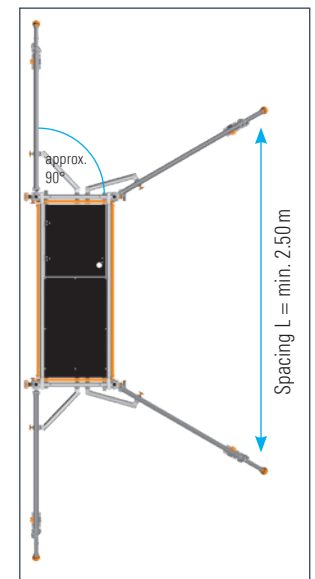

7. WALL BRACING (under compression) ANCHORING (under compression and tension)



For work performed on a load-bearing wall, ballasting can be reduced in accordance with the **Ballasting** table (see pages 10 – 12). In this case, wall supports or anchoring must be installed on both sides of the tower. Use the Uni distance tube **28** and fix it to the ladder frame **17/18** using two couplers **29** in each case. Position the rubber mount at the wall (see detail A) to provide support. Use the Uni distance tube, rotated by 180°, for anchoring and fit it into an eyebolt (see detail B) which was attached to the wall previously. The mobile beams must be installed so that they project from the side facing away from the wall. Attach the wall supports / anchoring at the height of the top working platform or at most 1 m below that.

 The wall support and anchoring are independent of the assembly variant. The figures are shown by way of example and refer to Safety Structure P2.

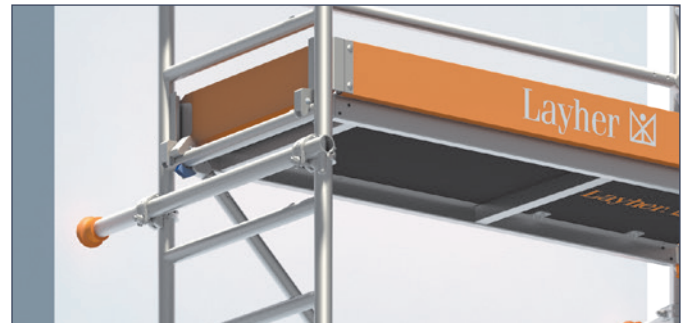

Detail A

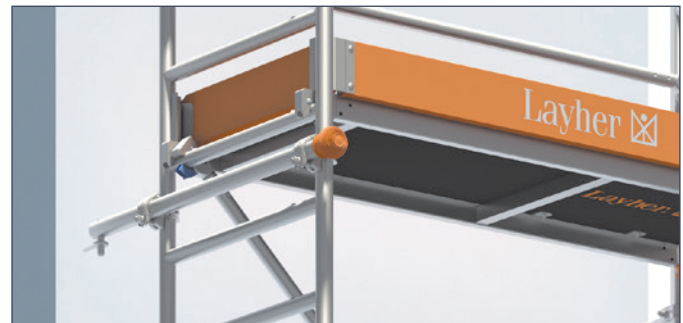

Detail B

8. COMPONENTS OF THE SYSTEM

1



1301.150 Castor 400, D=150 mm

Plastic wheel, with twin brake lever, permissible load: 4 kN (\approx 400 kg)

Functioning predecessor article 1308.150 (not shown) can remain in use.

2



1303.150 Castor 400, D=150 mm with polyurethane tyre

Plastic wheel with polyurethane tyre, special wheel for sensitive floors, permissible load: 4 kN (\approx 400 kg)

Functioning predecessor article 1309.150 (not shown) can remain in use.

3



1300.150 Castor, D=150 mm with base plate 250

Plastic wheel, with base plate, adjustment range 0.2 – 0.35 m, spindle nut with lock, wheel with twin brake lever and load centring when braked, permissible load capacity: 7 kN (\approx 700 kg)

4



1359.200 Castor 700

Plastic wheel, D=200 mm. With base plate, adjustment range 0.30 – 0.60 m, spindle nut with lock, wheel with twin brake lever and load centring when braked, permissible load: 7.0 kN (\approx 700 kg)

Functioning predecessor article 1259.200 / 1259.201 (not shown) can remain in use.

5



1358.200 Castor 700 with polyurethane tyre

Plastic wheel, D=200 mm. With base plate, adjustment range 0.30 – 0.60 m, spindle nut with lock, wheel with twin brake lever and load centring when braked, permissible load: 7.0 kN (\approx 700 kg)

Functioning predecessor article 1268.200 / 1259.201 (not shown) can remain in use.

6



1260.201 Castor 1000

Plastic wheel, D=200 mm of polyamide. With base plate, adjustment range 0.30 – 0.60 m, spindle nut with lock, wheel with twin brake lever and load centring when braked, permissible load: 10 kN (\approx 1,000 kg)

Functioning predecessor article 1260.200 (not shown) can remain in use.

7



1260.202 Castor 1000 with electrically conductive polyurethane tyre

Plastic wheel, D=200 mm of polyamide with tyre of electrically conductive polyurethane. **With base plate, adjustment range 0.30 – 0.60 m, spindle nut with lock, wheel with twin brake lever and load centring when braked. Permissible load 10 kN (\approx 1,000 kg). Special wheel for sensitive floors and, thanks to electrical conductivity, usable in explosion-proof or in ESD-risk areas, electrical leakage resistance as per DIN EN 12526 $< 10^4 \Omega$.**

8

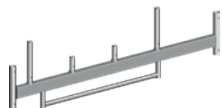

1323.180 Mobile beam with access ledger

Steel rectangular tube, hot-dip-galvanised

9

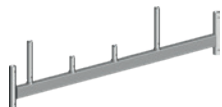

1214.180 Mobile beam

Steel rectangular tube, hot-dip-galvanised

10

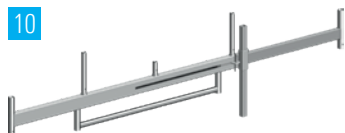

1323.320 Mobile beam with access ledger, adjustable

Steel rectangular tube, hot-dip-galvanised, system part for base widening

11



1338.320 Mobile beam with 2 spigots, adjustable

Steel rectangular tube, hot-dip-galvanised. For base widening in special rolling tower structures. System structures only possible in combination with Ref. No. 1337.000

12



1211.180 Basic tube

Steel tube, hot-dip-galvanised

13



1324.180 Base strut

with 2 half-couplers, steel tube hot-dip-galvanised.

14



1344.002 Access ledger

Aluminium

15



1249.000 Ballast (10 kg)

Steel, hot-dip-galvanised with half-coupler

16



1337.000 Spigot, adjustable

Steel, hot-dip-galvanised. For system structures in combination with Ref. No. 1338.320

17



1297.004 Ladder frame

Aluminium, rungs with non-slip grooving.

18



1297.008 Ladder frame

Aluminium, rungs with non-slip grooving.

19



1250.000 Spring clip
Steel

20



1205.180 Guardrail
Aluminium

21



1206.180 Double guardrail
Aluminium

22



1216.180 Safety double guardrail
Double guardrail 1.80 m, aluminium

23



1204.180 Uni telescoping guardrail
1.80 m + 2.85 m

24

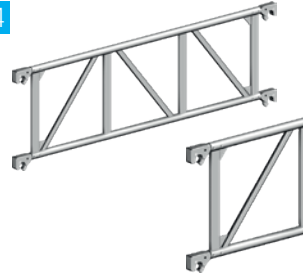

1207.180 Beam
Aluminium for use as support element in scaffolding construction kit or as double side protection.

25



1208.180 Diagonal brace
Aluminium

26



1208.195 Diagonal brace
Aluminium

27



1347.250 Deck diagonal brace
Aluminium

28



1275.110 Uni distance tube
Aluminium tube with hook and rubber mount.

29



4700.019 / 4700.022 Double coupler
Steel, galvanised

30

**1241.180 Deck**

Aluminium frame, with plywood deck with phenolic resin coating

31

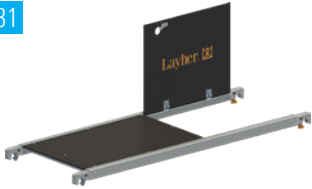
**1242.180 Access deck**

Aluminium frame, with plywood deck and hatch with phenolic resin coating

32

**1300.010 Uni assembly hook**

Pair

33

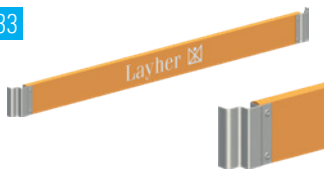
**1439.180 Toe board with claw**

Wood

34

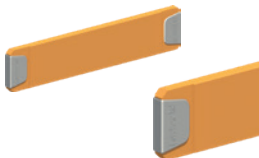
**1438.075 End toe board**

Wood

35

**1248.260 Stabiliser, extendable**

Aluminium

36

**1248.261 Rotation lock for stabiliser**

37

**6344.400 Tower identification block**

Block consisting of 50 units.

38

**6344.011 See-through pocket**

for Ref. No. 6344.400, 10 items with integr. prohibition sign

9. CERTIFICATE

In order to ensure up-to-date documentation, you can obtain the appropriate certificate on request using the contact details stated overleaf.



The currently available certificate applies to the assembly form **3.1 Rolling towers with Safety Structure P2**. Assembly forms **3.2 Rolling towers with Safety Structure P2 with Uni telescoping guardrail** and **3.3 Rolling towers with Safety Structure P2 SAFETY^{PLUS}** are currently undergoing certification and the corresponding certificates will be made available as soon as they have been issued.







Layher® 

More Possibilities. The Scaffolding System.

Wilhelm Layher GmbH & Co KG
Scaffolding Grandstands Ladders

Ochsenbacher Strasse 56
74363 Gueglingen-Eibensbach
Germany

P.O. Box 40
74361 Gueglingen-Eibensbach
Germany
Phone +49 (0)7135 70-0
Fax +49 (0)7135 70-265
E-mail info@layher.com
www.layher.com